

**SOLUTIONS BOOK\_WINTER 2016/2017 ENGLISH**



***Your foot company™***







[www.sidas.com](http://www.sidas.com)



**In 1975, Sidas was established by three ski instructors looking for ways to make skiers' feet more comfortable. The brand founders decided to make insoles moulded to each individual foot shape to provide more sensation and reduce discomfort inside ski boots. Not having specialised tools to hand, they moulded their first insoles with an oven dish and a cushion! The venture was a success, and so began the company's long history!**

Sidas then began to grow rapidly, providing comfort solutions not only for skiing but also other sports such as running, outdoor sports and cycling, as well as for everyday footwear.

**For 40 years, Sidas' growth has been assured by its commitment in different areas:**

- Innovation, which has been at the heart of Sidas' growth for forty years, and has resulted in the company registering 109 trademarks and 15 patents.
- Sidas has become the brand of choice of top athletes in a number of sports worldwide, thanks to its innovative solutions.
- Collaboration with experts to validate Sidas products and their benefits through scientific studies.
- Sidas solutions are recommended by top partner brands.
- The confidence of retailers and foot professionals. More than 15,000 retailers and foot professionals work with Sidas products.
- The popularity of the brand among the 1.5 million people who use its products daily!

Sidas provides solutions for every type of foot and every sport, every day!





**FUELLED BY INNOVATION**

109 registered trademarks  
15 registered patents  
5 awards

**CHOSEN BY ATHLETES**

Sidas provides solutions for all the top athletes, in each sport, worldwide



**PROVEN BY EXPERTS**

Proven in scientific studies  
by an expert team



# X6 STEPS TO SUCCESS



## RECOMMENDED BY PARTNERS

Sidas solutions are used and recommended by the top brands and organisations



## TRUSTED BY RETAILERS

Sidas services and solutions are used and trusted by more than 10,000 retailers



## LOVED BY END-USERS

Sidas solutions are loved by 1,500,000 daily-users





# ATHL

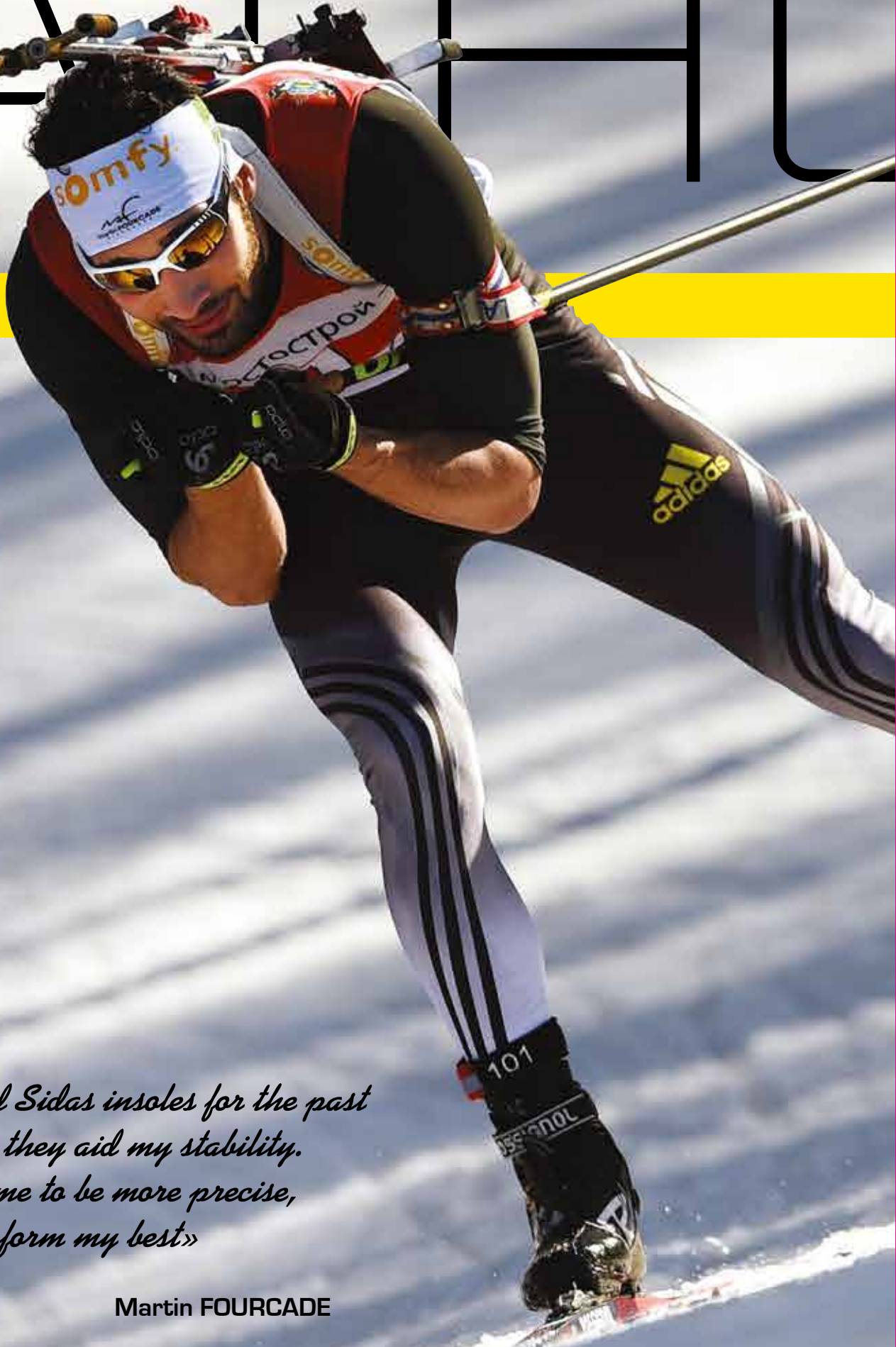

*« I've used Sidas insoles for the past few years, they aid my stability. Allowing me to be more precise, and to perform my best»*

Martin FOURCADE

# LET'S



**Martin FOURCADE**  
Biathlon

Seven time world champion  
Two time Olympic champion -  
Sotchi 2014



**Maurice MANIFICAT**  
Cross country skiing

World championships runner-up  
Bronze medalist -  
Olympic Games - Sotchi 2014







Martin FOURCADE - Biathlon



Benoit VALENTIN - FS ski



Bastien MIDOL - Ski cross



Marie DORIN - Biathlon



Alan BAXTER - Alpine ski



Marion JOSSERAND - Ski cross



Thomas MERMILLOT BLONDIN - Alpine ski



Xavier BERTONI - FS ski



Simon FOURCADE - Biathlon



# ATHLETES



Ed DRAKE - Alpine ski



Hoshino JUNKO - Moguls

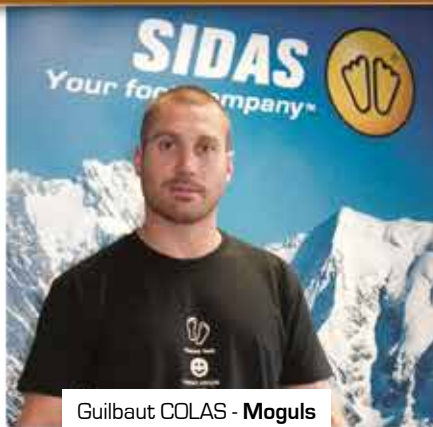

Guilbaut COLAS - Moguls



Maurice MANIFICAT - Cross-country ski



Julien LOPEZ - FR ski



Marie MARCHAND ARVIER - Alpine ski



Marion ROLAND - Alpine ski



Tony RAMOIN - Snowboard cross



Perrine LAFFOND - Moguls



Sophie RODRIGUEZ - Snowboard





# 3D DESIGN

3D insoles that are pre-shaped and provide the ultimate in comfort thanks to their 3D design.

This form supports the foot and aligns the body, giving optimum stability and comfort.

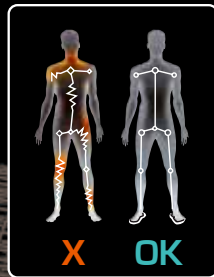



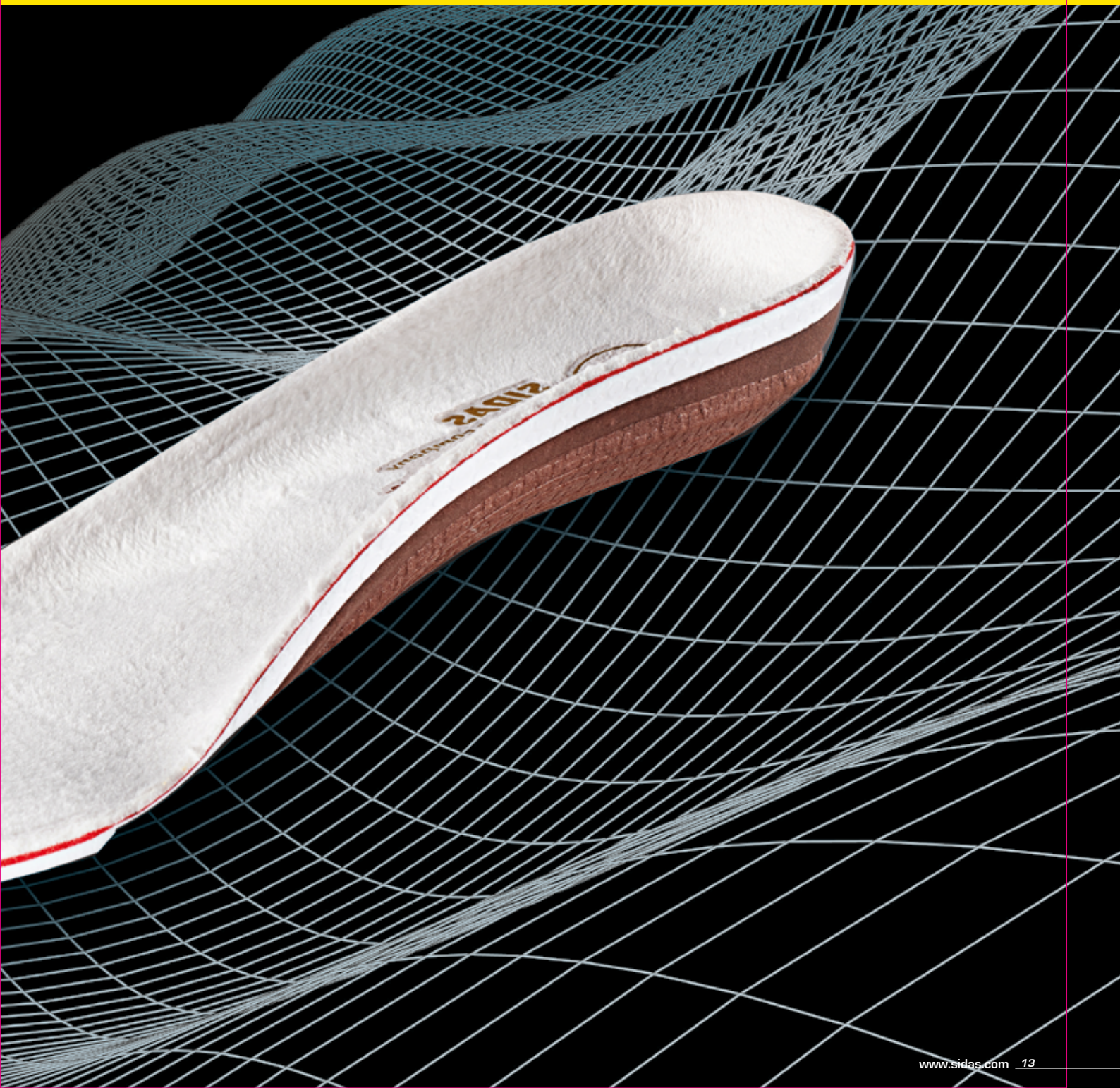

# 3Feet®

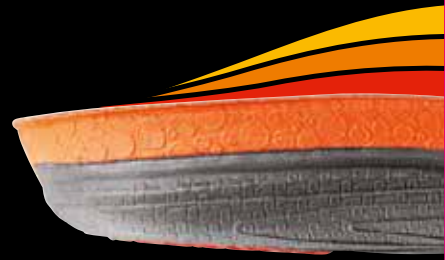

Feet differ in three main ways; their shape, movement and pressure.

Despite these differences, they can generally be grouped into three categories, each with their own distinct needs: High arch feet - Mid arch feet - Low arch feet.

The biomechanical construction of the 3Feet® range is therefore adapted to the three different arch types.

We have insoles, socks and sandals for each type of foot!



**HIGH**





**MID**



**LOW**



# FLASHFIT™



## THE PREMIUM 3D

Flashfit™ technology allows 75% customization of your insoles in only a few minutes. The bootfitter heats a pre-shaped insole and fits it to your foot in less than 5 minutes. Only part of the insole can be fully customized to your foot, the other pre-shaped part remains unchanged when heated. With Flashfit™ insoles, you have more power, control and comfort.



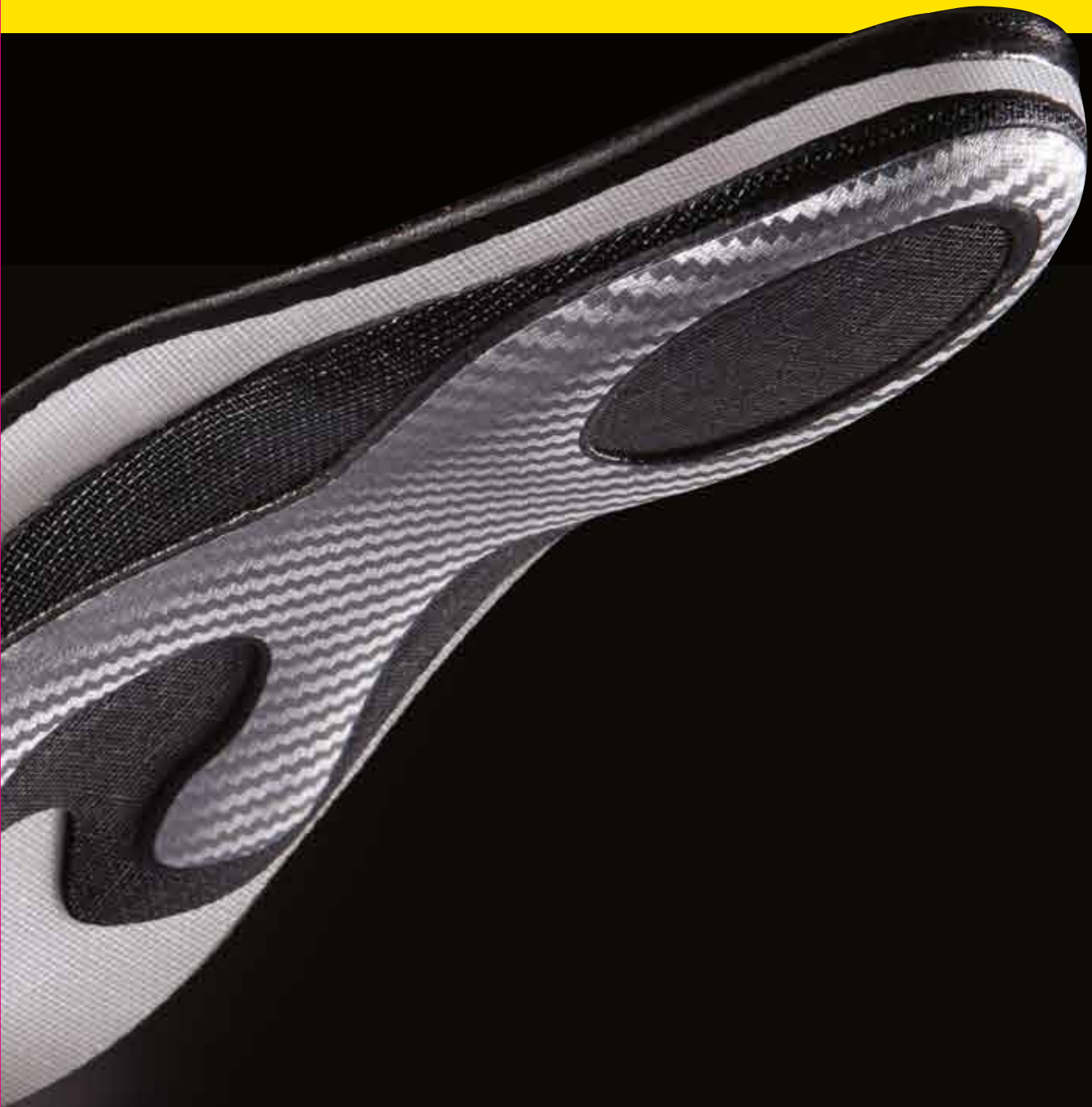



# C | Custom

## 100% MADE FOR YOU

Custom technology offers complete customisation of your insoles. With a flat insole, the bootfitter heats the insoles and then moulds them. When it is placed on your footprint, the Custom insoles hugs the shape of your foot for the highest levels of comfort and support.







# ANALYSIS



# MEASURING AND ANALYSIS TOOLS

## SKIER ANALYSE STATION

COUCHSKANSTA 15

This analysis station offers the technician all the equipment necessary to conduct a fast and effective analysis of the skier's foot in order to facilitate the choice of a shell and recommend a boot-fitting solution.

It consists of a double measurer L / XL (choice of shell size and model), a mobile alignment laser (for verifying alignments and recommending the insole) and a boot-spreader for validating the shell volume.

The Fit Sticks are not included.

 Developed and made in France

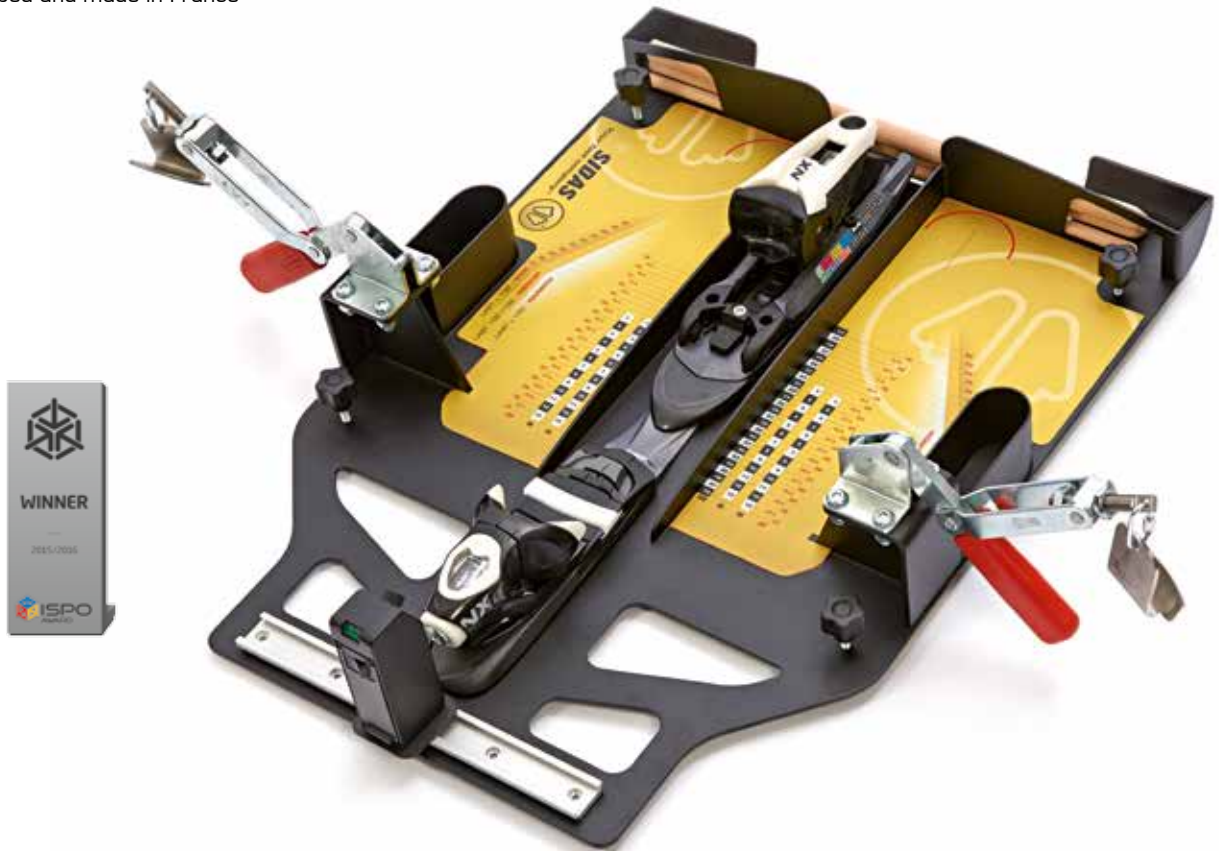

See page 100 for all Sidas training



## SKIER ANALYSE STATION PROCESS

Process:



# MEASURING AND ANALYSIS TOOLS

## PRESS-CAM V4.0

AMPRESSCAM2

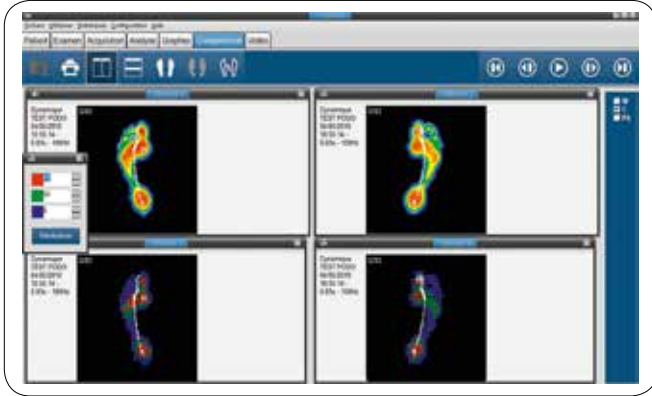

The Presscam V4 is a hybrid pressure-posturology platform that complies with Directive 93/42/EEC and is certified by DEKRA. It features new-generation software (electrical power supply provided via a USB cable) with new functions and presentation modes.

Seven main criteria can be viewed:

- Clinical examination report with statistical processing.
- Static plantar pressure.
- Dynamic plantar pressure and comparison (scan at 100 Hz; higher than some other platforms which scan at 40 Hz).
- Movement of pressure centres (PCs) over a given time (at 40 Hz).
- Multi-footstep acquisition
- LAMFI read-out.
- Comparative heel-forefoot analysis.

**Dimensions** (width/length) 550 x 661 mm

**Active surface area** 400 x 400 mm

**9mm-thick base**

**Weight** 3 kg



## LASER ALIGNMENT SYSTEM

CMAVALASER12

Top-quality laser used to check leg alignment. Attaches easily to the Fit Station.



## FIT STICKS + LIGHT

CCHDCFITSTIC

3 sticks of varying thickness (diameter: 10 mm - 15 mm - 20 mm) for measuring the space available in the boot and to confirm the choice of shell size.  
Sold as a kit or alone.





PODOSCOPE M

APODOSCONF

A podoscope that combines two features: a mirror system for viewing the foot print & direct measurement of Mondo point foot sizes.

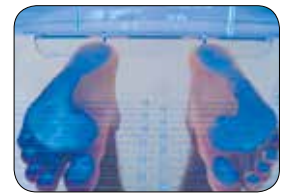

FEET REVELATOR™

ABFEETREVE12



Scan this QR code to view our brand new film about the Feet Revelator™ process:



A revolutionary foot measurer! With the feet revelator™ you can determine your customer's foot type and characteristics in an instant. It not only measures the length and width of any foot but also reveals the footprints. Simple to use: just open and close to erase your customer's footprints.



1. Ask the customer to stand on the Feet Revelator™.
2. Measure the length and width of the customer's feet.
3. Ask the customer to step off the Feet Revelator™ for the footprint analysis.
4. Open and re-close the Feet Revelator™ to erase your customer's footprints.

FEET MEASURER

ABMES-SPORT-DBLE12

Instrument that measures the length and width of both feet. 4 sizing systems (EUR/US/UK/MP). Simple to use and robust (plastic). Includes a handle for easy carrying.



FOOT SIZER

ABMESPORT12-1FOOT

Instrument that measures the length and width of the right foot. 4 sizing systems (EUR/US/UK/MP). Simple to use and robust (metal).





# INSOLES





# SOLES





# RENTAL



# RENTAL

This new concept is dedicated to the rental area of partner shops.



## RENTAL 3D

CSESIREN16 (box of 10)



A 3D insole that provides enhanced comfort and hygiene (sanitized treatment).

This insole is available in 15 sizes and can be integrated into all the rental boots, or bought by the customer in the shop.

**Sizes:** 18.5, 19.5, 20.5, 21.5, 22.5, 23.5, 24.5, 25.5, 26.5, 27.5, 28.5, 29.5, 30.5, 31.5, 32.5

1. Highly resistant Merry Mesh with an antibacterial coating for **ENHANCED HYGIENE**
2. 3mm EVA foam: **COMFORT**
3. 3D EVA shell = **OPTIMUM PROTECTION AND SUPPORT** on the slopes for enhanced comfort, enjoyment and reduced fatigue



Antibacterial



## SANISOL 3D

CSESISAN3D13 (box of 10)



An insole designed to provide good foot support when practicing winter sports. It has an antibacterial top layer.

**Sizes:** 18, 19, 20, 21, 22, 23, 24, 25, 26, 27, 28, 29, 30, 31, 32

1. Antibacterial MerryMesh top layer
2. EVA shore A 40: **COMFORT & LIGHTNESS**



Antibacterial

# 3D INSOLES



## WINTER 3D COMFORT

CSE3DWICOMF16



3D insoles designed for winter activities such as winter walking, skiing and snowboarding. For foot support, thermal insulation and improved comfort.

Sizes: XS-S-M-L-XL-XXL

1. Synthetic fur: **SOFTNESS & WARMTH**
2. EVA shell: **FOOT SUPPORT & STABILITY**
3. Aluminium film: **THERMAL INSULATION**
4. PU Comfort Foam: **COMFORT AND WARMTH**

DIMENSIONS (mm)

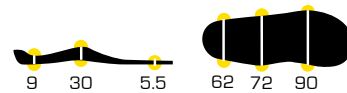

## MARKETING



**Demokit Winter 3D Comfort**  
CSE3DDKWICOM16



**Foot Sizer**  
ABMESPORT 12-1FOOT



**Mid Display**  
CMKPMIDDI12



WINTER 3D COMFORT WOMEN

CSE3DWICOMFW14



3D insoles designed for winter sports and tailored to the anatomy of women's feet. For use when skiing, and also improves comfort in any other type of shoe or boot. These insoles increase warmth and comfort. Their 3D structure provides perfect foot support and encourages correct body alignment.

Sizes: XS-S-M-L

- 1. Fleece covering: **WARMTH AND SOFTNESS**
- 2. 3D technology: **SUPPORT AND STABILITY**
- 3. Aluminium film: **INSULATION**
- 4. Ortholite: **COMFORT AND WARMTH**

DIMENSIONS (mm)

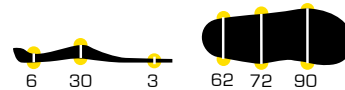

WINTER 3D

CSE3DWINT12



Insoles designed for snowsports that are within everyone's reach. Suited for skiing as well as snowboarding, a ready-to-wear insole that positions and holds your foot for optimum comfort.

Sizes: XS-S-M-L-XL-XXL

- 1. Velvet topcover: **COMFORT & DURABILITY**
- 2. Nylon shell: **SUPPORT & STABILITY**
- 3. EVA pad: **CUSHIONING**
- 4. Aluminium film: **INSULATION**

DIMENSIONS (mm)

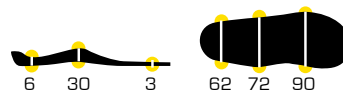

MARKETING



**Demokit Winter 3D**  
CSE3DDKWIN12



**Demokit Winter 3D Women**  
CSE3DDKWICOMW14



**Poster Winter 3D**  
CMKPOSWI3D14

# 3Feet®

3Feet® REVOLUTION: 3Feet® biomechanical construction is adapted to the 3 different arch types. For each foot, there is an insole!



## WINTER 3FEET® HIGH

CSE3FW112-HI



Specifically designed for high arch feet.  
Need: support.  
3Feet® answer: Optimised pressure distribution.  
- Aluminium film for insulation.  
- Anatomical construction adapted to high arch feet.  
- Large foam pad for greater cushioning.

**Sizes:** XS-S-M-L-XL-XXL

1. Velvet topcover: **COMFORT & DURABILITY**
2. EVA shell high arch shape: **FOOT SUPPORT & PRESSURE DISTRIBUTION**
3. EVA pad: **CUSHIONING**
4. Aluminium film: **INSULATION**



HIGH ARCH

## WINTER 3FEET® MID

CSE3FW112-MI



Specifically designed for medium arch feet.  
Need: comfort.  
3Feet® answer: Optimised vertical comfort.  
- Aluminium film for insulation.  
- Anatomical construction adapted to medium arch feet.  
- Foam pad for greater cushioning.

**Sizes:** XS-S-M-L-XL-XXL

1. Velvet topcover: **COMFORT & DURABILITY**
2. EVA shell mid arch shape: **FOOT SUPPORT**
3. EVA pad: **CUSHIONING**
4. Aluminium film: **INSULATION**



MID ARCH

## WINTER 3FEET® LOW

CSE3FW112-LO



Specifically designed for low arch feet.  
Need: stability.  
3Feet® answer: Optimised foot stability.  
- Aluminium film for insulation.  
- Anatomical construction adapted to low arch feet.  
- Foam pad for greater cushioning.

**Sizes:** XS-S-M-L-XL-XXL

1. Velvet topcover: **COMFORT & DURABILITY**
2. EVA shell low arch shape: **FOOT SUPPORT**
3. EVA pad: **CUSHIONING**
4. Aluminium film: **INSULATION**



LOW ARCH

# 3Feet® MARKETING TOOLS

## 3FEET® DIGITAL CORNER

GMK3FCORNERV1-1

An interactive display that allows your customers to analyse their feet and select the appropriate 3Feet® solution.

Quick, fun and easy to use: a unique experience for your customers and a real point of difference for your store.

Composed of a pressure analysis device connected to a tactile touch-screen computer.

Movie available in English, French or German.

Scan this QR code to view our brand new film introducing the 3Feet® Digital Corner.



Designed to accommodate up to 15 pairs of 3Feet® Socks / 45 pairs of 3Feet® insoles. Includes also 3 shelves to highlight the 3Feet® sandals



Pressure analysis device

## PROCESS

1. Take off your shoes.
2. Stand on the pressure analysis device.
3. Touch the screen to begin the process.
4. Your foot type and the appropriate 3Feet® solutions are displayed on screen.
5. Select the appropriate 3Feet® products from the display.





FLASHFIT



**FLASHFIT™**



FLASH, FIT and GO!



## FLASHFIT™ PADS

CMAVAPAD-FF12  
 CMAVAPAD-FF-NU = Pads alone  
 CMAVAPAD-FF-Cl = Bottom wedge  
 CMAVAPAD-FF-CL = Side wedge

The foam pads have two removable reinforcements, are softer and have a new anatomical shape, all of which make moulding easier. Available in one size.



## FLASHFIT™ BOX

110V: CMAFLASHfit1 / 220V: CMAFlashfit2

The concept that heats Flashfit™ insoles in less than 10 seconds. Easy, fast, compact, unique design = The Flashfit™ revolution. Dimensions: 12 x 30 x 38 cm - 7 kg.



See page 100 for all Sidas training

## FLASHFIT™ PROCESS

Process:



# FLASHFIT™ INSOLES



## WINTER+ COMFORT

CSESPWICOMF16



Pre-shaped insoles designed to provide optimum comfort for winter activities such as winter walking, skiing and snowboarding. For foot support, insulation and warmth. These insoles can be personalised to your feet in less than 10 minutes using Flashfit™ technology.

Sizes: XS-S-M-L-XL-XXL

1. Micro fleece topcover:  
**COMFORT**
2. Transflux® C reinforcement:  
**FOOT SUPPORT & STABILITY**
3. Transflux®:  
**FLEXIBILITY & COMFORT**
4. Transflux®:  
**ARCH SUPPORT**

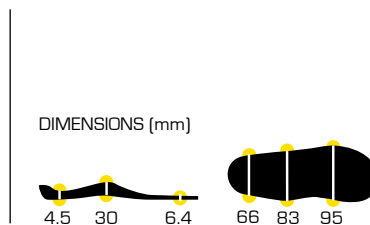

## WINTER+

CSESPWINT12



Pre-shaped insoles designed for winter sports such as skiing and snowboarding, for optimum comfort. Foot support, stability to prevent overheating and fatigue. Can also be customised to your feet in less than 10 minutes using Flashfit™ technology for additional comfort.

Sizes: XS-S-M-L-XL-XXL

1. Ionmesh® topcover:  
**CUSHIONING & ANTIBACTERIAL**
2. Transflux® C reinforcement:  
**SUPPORT & STABILITY**
3. Podiaflex® N:  
**SUPPORT & STABILITY**
4. Eco foam pad:  
**COMFORT & DURABILITY**

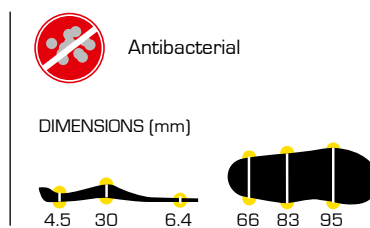

To reduce the environmental impact, the materials used are either recycled (N Podiaflex, new eco resin; Ortholite), or recyclable; at the same improving the biomechanical properties of the insole.

## MARKETING

### Demokit WINTER+ COMFORT

CSESPDKWICOMF16



### Demokit WINTER+

CSESPDKWIN12



### Demokit WINTER+ Slim

CSESPDKWSL12





# FLASHFIT™

## WINTER+ SLIM

CSESPWINSL12



Pre-shaped insoles for winter sports such as skiing and snowboarding, designed for slim-fitting footwear. Foot support, stability, prevent overheating and fatigue. Can also be customised to your feet in less than 10 minutes using Flashfit™ technology for additional comfort.

Sizes: XS-S-M-L-XL-XXL

- 1. Ionmesh® topcover: **CUSHIONING & ANTIBACTERIAL**
- 2. Transflux® C reinforcement: **SUPPORT & STABILITY**
- 3. Podiaflex® N: **SUPPORT & STABILITY**



Antibacterial

DIMENSIONS (mm)



## FLASHFIT™ DISPLAY

CMKDISPLAYFULL12FF

New all-in-one display unit featuring packaging on both sides, the Feet Revelator™, the new foam pads and the Flashfit™ machine. The back of the display unit features an explanation of the Flashfit™ insole moulding process. Sold separately.

Dimensions: 50 cm x 120 cm x 140 cm

- 1. Flashfit™ unit (delivered without packaging and without equipment)
- 2. Flashfit™ pads (not included)
- 3. Flashfit™ box (not included)
- 4. Feet Revelator™ (not included)



## TOOLS

**Feet Revelator™**  
ABFEETREVE12



**Footbed templates**  
CSEAGABHIVE



**Scissors**  
CSEACCIS





CUSTOM

**C | Custom**

100% MADE FOR YOU & YOUR SPORT





## CUSTOM STATION

CUSTOM STATION PREMIUM PACK - CMAJUSTAPREMPK15 full equipped  
FIT STATION PREMIUM - CMAFITSTAPREM15 without equipment

The new premium fit station is the must-have Custom moulding station!

Its ergonomic, elegant and simple design lets you promote your boot-fitting activity in-store, particularly the Custom technology.

The design ensures both comfort for the boot-fitter and simple moulding.

The station is easy to access for both the customer and the technician. It consists of a comfortable adjustable seat and support bars to ensure stability for the customer during the moulding process.

A luminous band emphasises the outline of the station and promotes your boot-fitting space.

In technical terms, the sophisticated station allows you to analyse feet using the fully-integrated podoscope, to heat using the Moduvac and to make imprints using the directly integrated silicone bags.

5-year guarantee on the equipment.

Lifetime guarantee on metal structure.

Dimensions : 1068 x 925 x 895 mm.

1. Fit Station Premium
2. Integrated **PODOSCOPE**
3. Adjustable seat
4. **MODUVAC**
5. Moulding module

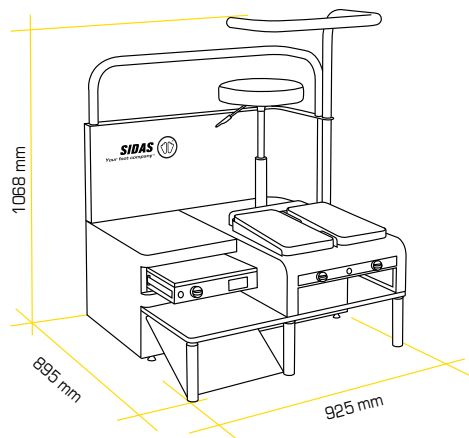

Developed and made in France



See page 100 for all Sidas training

## CUSTOM PROCESS

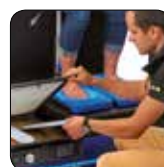
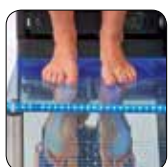

# CUSTOM STATION COMPACT

CUSTOM STATION COMPACT PACK (incl. Moduvac, Hdvac, Podoscope) - *CMACUSTACOMPK15*  
 CUSTOM STATION COMPACT ANALYSE (incl. Podoscope) - *CMFITSTACOMPAN15*  
 FIT STATION COMPACT without equipment - *CMFITSTACOMP15*

This new fit station is a highly compact unit that combines all the essential elements for customising the design of insoles. It offers the very best function / size / quality ratio.

Its ergonomic metal structure is highly resistant, allowing optimum use of your boot-fitting space. It consists of a seat, an analysis section and a moulding section, all ideally dimensioned for your point of sale or sales visits.

Dimensions : 1106 x 710 x 639 mm.

1. Fit Station Compact
2. MODUVAC
3. Podoscope
4. Integration of Feet Measurer possible
5. Sidas Bootfitting Cube *GMKSIDASBFCUBE15*

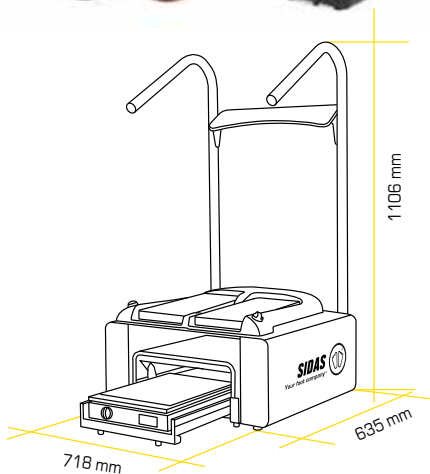

Developed and made in France



See page 100 for all Sidas training

## CUSTOM PROCESS

Process:



## CUSTOM STATION 2.1

MBFSTAT2.1 WITHOUT EQUIPMENT

For retailers who want to offer a totally professional service and the best customer experience. The Fit Station is a unit especially designed for boot-fitters.

[The HD Vac 2 and the Moduvac are not included and should be bought separately].

Dimensions: 90 x 80 x 89 cm.

**1. FIT STATION** MBFSTAT2.1

**2. HD VAC 2** 110V : CMAVAHD09-1 / 220V : CMAVAHD09-2

**OPTIONAL:**

**3. MODUVAC** 110V : CMAMODU09-1 / 220V : CMAMODU09-2

**4. LASER ALIGNMENT SYSTEM** CMAVALASER12  
[see page 22, Analysis section]

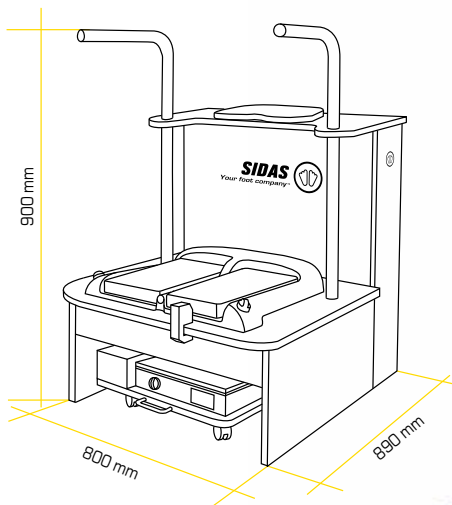

See page 100 for all Sidas training



## CUSTOM PROCESS

Process:







## HD VAC 2

110V: CMAVAHDBLK-1 / 220V: CMAVAHDBLK-2

The best just got better. The HDVAC was already the best Custom system on the market, but the HDVAC2 is the most precise system ever made. The new silicon bags can be stretched up to 800% to adapt to any foot shape, the bags are separated for better heel adaptation, and all the controls are on the front making it easier for the boot-fitter to operate. For retailers who want to offer a complete professional service, this tailor-made product will enhance your custom business line. If you want to bring the best service to your customer, the HDVAC2 is for you.

*The HDVAC 2 is a system for moulding comfort insoles, but cannot replace plantar orthoses fitted by professional foot specialists.*



## MODUVAC

110V: CMAMODU09-1 / 220V: CMAMODU09-2



The new Sidas system to accompany the HDVAC2 system for moulding Custom footbeds. Compact, fast and simple, the Moduvac heats and presses the footbeds using a vacuum system in order to fuse the materials together, and prepare the insoles for moulding. The Moduvac is compatible with all HDVAC systems.

## MARKETING



**Sidas Bootfitting Cube**  
CMKSIDASBFCUBE15

Dimensions: 0.40 m x 0.40 m.



**Custom Poster for Fit Stations**

EN: CMKPOSCUSTOM\_02  
FR: CMKPOSCUSTOM\_05  
DE: CMKPOSCUSTOM\_01

Dimensions: 60 cm x 80 cm.

# CUSTOM INSOLES

## WINTER CUSTOM COMFORT

CSECUWICOMF14



**COMFORT zone:**  
The Expertene™ foam pad on the forefoot ensures unrivalled comfort.



The new Custom Comfort is a ski-specific insole that offers unrivalled forefoot comfort whilst enabling you to maintain precise control of your ski edges. The AMF microfibre top cover helps to give this insole a premium quality feel that lasts all day.

Sizes: XS-S-M-L-XL-XXL

- 1. AMF topcover: **SOFT TOUCH & EASY STEP IN**
- 2. Podialène foam 2.5 mm: **CUSHIONING ACROSS THE ENTIRE INSOLE**
- 3. Expertene padding: **OPTIMAL COMFORT**
- 4. Podiafix® reinforcement: **FOOT STABILITY & CONTROL**
- 5. Transflux® reinforcement: **BACK FOOT STABILITY**
- 6. Transflux®: **COMFORT & SOFTNESS**

DIMENSIONS (mm)

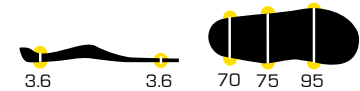

## WINTER CUSTOM RACE

CSECUWIRAC12



Very thin, 100% customisable insoles, designed for slim-fitting boots.

Sizes: XS-S-M-L-XL-XXL

- 1. Thin foam topcover: **CUSHIONING IN LOW SHOES VOLUME**
- 2. Narrow shape: **FOR NARROW BOOTS**
- 3. Transflux® reinforcement: **FOOT SUPPORT & RIGIDITY**
- 4. Podiafix®: **PRECISION**

DIMENSIONS (mm)

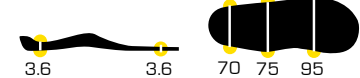

## WINTER CUSTOM PRO MESH

CSECUWIPRME12

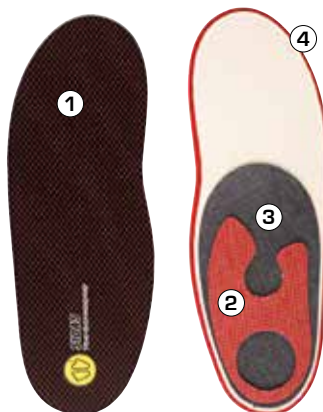

The new Custom Ski Pro Mesh is designed for skiers who are looking for unrivalled comfort and performance. New materials that are easier to mould to the feet, and an Ionmesh® top layer, which makes it easier to slip your feet into your ski boots.

Sizes: XS-S-M-L-XL-XXL

- 1. Thin foam topcover: **CUSHIONING IN LOW SHOES VOLUME**
- 2. Narrow shape: **FOR NARROW BOOTS**
- 3. Transflux® reinforcement: **FOOT SUPPORT & RIGIDITY**
- 4. Podiafix®: **PRECISION**



Antibacterial

DIMENSIONS (mm)

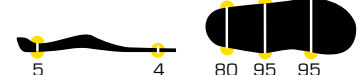

WINTER CUSTOM PRO

CSECUWIPR12



The new Custom Ski Pro is designed for skiers who are looking for incomparable comfort and performance. Constructed using new materials that mould more easily to the feet.

Sizes: XS-S-M-L-XL-XXL

- 1. Ionfoam® topcover: **CUSHIONING & ANTIBACTERIAL**
- 2. Transflux® reinforcement: **SUPPORT & STABILITY**
- 3. Transflux®: **SUPPORT**
- 4. Podiafix®: **PRECISION**



Antibacterial

DIMENSIONS (mm)

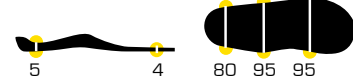

WINTER CUSTOM WIDE

CSECUWIID12



Broad Custom Ski insole for wide-fitting ski boots. Ionmesh® for an easy entry in the boots.

Sizes: XS-S-M-L-XL-XXL

- 1. Ionmesh® + Ionfoam® topcover: **CUSHIONING & ANTIBACTERIAL**
- 2. Podiaflex® reinforcement: **FOOT SUPPORT & STABILITY**
- 3. Podiafix®: **PRECISION**



Antibacterial

DIMENSIONS (mm)



WINTER CUSTOM SKI

CSECUWISK12



The essential insole. Can be used alone but is most often stabilized with Heel stabs or Transflux® reinforcements.

Sizes: XS-S-M-L-XL-XXL

- 1. Ionfoam® topcover: **CUSHIONING & ANTIBACTERIAL**
- 2. Podiaflex® reinforcement: **FOOT SUPPORT & STABILITY**
- 3. Podiafix®: **PRECISION**



Antibacterial

DIMENSIONS (mm)

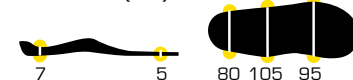





# MODULO RACING

This offer is exclusively reserved to boot-fitting experts. It has been developed by specialists and approved by athletes. This premium offer is used for the customised design of high-performance insoles adapted to skiers' needs and disciplines (both alpine and nordic). Sidas has allowed no compromise in ensuring that it only creates the best possible insoles for athletes and only uses the best materials approved by its R&D team.

Delivered in packs of 5 pairs.

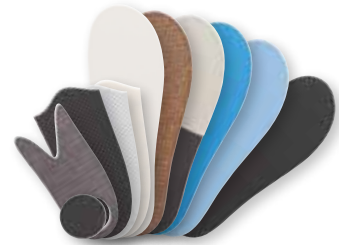
The use of this Racing module necessitates Sidas Expert training (see Sidas training on page 100). Specials conditions applied on request.



Top covers (XS - XXL)		
 <b>Top cover Racing 0.8mm</b> <i>CSEMODRACRVO1</i> 5 pieces pack.	 <b>Top cover Racing 1.5mm</b> <i>CSEMODRACRVO2</i> 5 pieces pack.	 <b>Top cover Racing 2.5mm</b> <i>CSEMODRACRVO3</i> 5 pieces pack.
Mid layer (XS - XXL)		
 <b>Mid layer Racing 2mm</b> <i>CSEMODRACINTO1</i> 5 pieces pack.		
Base (XS - XXL)		
 <b>Base Racing 0.8mm</b> <i>CSEMODRACBAO2</i> 5 pieces pack.	 <b>Base Racing 1.6mm</b> <i>CSEMODRACBAO1</i> 5 pieces pack.	
Medio (XS - XXL)		
 <b>Mid foot Racing 1.1mm</b> <i>CSEMODRACRFO3</i> 5 pieces pack.	 <b>Mid foot Racing 1.5mm</b> <i>CSEMODRACRFO2</i> 5 pieces pack.	 <b>Mid foot Racing 2mm</b> <i>CSEMODRACRFO1</i> 5 pieces pack.
Rear (XS - XXL)		
 <b>Heel Racing 1.1mm</b> <i>CSEMODRACSRFO1</i> 5 pieces pack.		
Pads (T1 - T3)		
 <b>Pad Racing 2mm</b> <i>CSEMODRACPAO1</i> 5 pieces pack.		

# CREATE YOUR OWN INSOLES

Insole offers available, including the Winter Custom Ski, Winter Custom Pro, Winter Custom Pro Mesh and Winter Custom Comfort.

## • Order 200 pairs:

### We print your logo here

Bootfitter logo printed on the top cover (10x3cm)



## • Order 350 pairs:

### We print your logo here

Bootfitter logo printed on the top cover (10x3cm)



**Choose:**  
• the reinforcement  
• the shape

### A choice of top cover materials

Dark grey 2mm - Red & Black 2.5mm -  
Black 2mm - Light grey 2.5mm - Blue 2.5mm

# CUSTOM ACCESSORIES

## HEEL STAB 65

CSEACSTA65

NEW  
2016  
2017



The Heel Stab 65 stabilizes the Custom insoles. Thanks to its new anatomical design, the Heel Stab 65 is easy to position. The Stab requires less grinding.

Sizes: XS - XXL

INSOLES

## HEEL STAB

CSEACSTA



Pre-glued PE stabilizer. Easy to fit and grind, for light reinforcement and lateral stability.

Sizes: 1 (XS-S) 2 (M-L) 3 (XL)

## HEEL STAB STIFF

CSEACSTASTIF



The same concept as the heel stabilizer (Heel stab), but stiffer and available in 4 sizes.

Sizes: 1 (XS) 2 (S-M) 3 (L-XL) 4 (XXL)



See page 100 for all Sidas training



## HEEL STAB PROCESS

Process:





**HEEL STAB COVER**

CSEACSTACOV



EVA coating giving a better finish on the heel stab. Easy to affix to the heel stab thanks to its adhesive.

Features: EVA shoreA 70, 1mm black. Sold in packs of 5 pairs.

Sizes: T1-T2 / T3-T4



**CRIST'AIR STAB**

CSEACSTCRISR



A revolutionary material with unrivalled properties: ultra light (density 100 kg/m<sup>3</sup>); easy to cut and grind. Extra control of both the rear-foot and mid-foot.

Sizes: 1 (XS-S) 2 (M-L) 3 (XL)



See page 100 for all Sidas training

**CRIST'AIR PROCESS**

Process:



# CUSTOM ACCESSORIES

## HEEL BARS







CSEACSTHEELBARS



Heel bars are the quick way to stabilise the rear foot. They are 10 mm wide and made of shore A70 EVA. They feature an adhesive-coated section which makes them easy to stick to the insole. Sold in packs of 10 pairs.



## TRANSFLUX® REINFORCEMENT INSOLES

	<b>TX® white</b> (1.5 mm)	CSEACRETX3		<b>TX® blue</b> (1 mm)	CSEACRETX4
	<b>TX® orange</b> (1.5 mm)	CSEACRETX1		<b>TX® orange</b> (1.5 mm)	CSEACRETXM3
	<b>TX® black</b> (1 mm)	CSEACRETX2		<b>TX® orange</b> (1.5 mm)	CSEACRETXR3

Sizes: XS - S - M - L - XL - XXL / Sold in pack of 5 pairs

## FOOTBED TEMPLATES

CSEACGABHIVE



Templates for checking shoe or liner size.

## SCISSORS

CSEACCS



Strong scissors for cutting footbeds.

## NEOPRENE GLUE 1L

P99COLLE1



## OK NET

COUACDK



Cleaning spray for analysis and measurement tools, machine pads, scan...

# HEAT INSOLES

## CUSTOM HEAT

CSECUHEAT12

Custom Ski insole with directly integrated warming elements.

Easy to mould to the customer's feet, the Custom process remains the same.

Compatible with all the batteries in the Sidas range.

Sizes: XS - XXL



## VOLCANO HEAT

CSESIVOLCH12

The warming 3D insole combines high-performing warming elements for real thermal comfort, and also provides exceptional support and cushioning of the foot.

Compatible with all the batteries in the Sidas range.

Sizes: XS - XXL



## WINTER H FLAT

CSESIWINTERH

The soft fabric top layer provides good cushioning and insulation from the cold. Multi-size insole with handy trimming lines on the reverse.

Compatible with all the batteries in the Sidas range.

Sizes: TU



## HEATING ELEMENTS & COVER

CSECUHELT10  
CSECUHTOP10 (HEAT COVERS)

**The custom designed insole.** Includes Custom SIDAS coverings and warming elements for insoles. In the shop, the expert boot-fitter fully adjusts the insoles to the feet and the sport, with the added comfort of warmth. Works with SIDAS batteries. The pack includes 2 top covers and 2 heating elements.

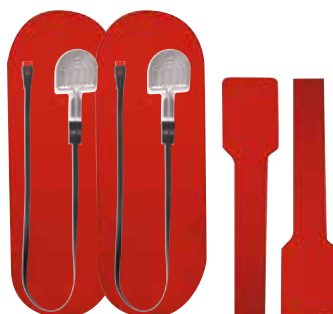

The new heating element is thinner and more effective. The thinner element is easier to fit in the Custom insoles, and its new connector makes it more resistant to external stress. The connection has been reinforced to make it more robust and longer-lasting.

## HEATING ELEMENTS PROCESS

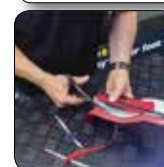
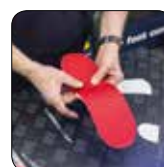



# BATTERIES

## PRO

HEPRO12



The most powerful battery in the range.

This battery with its modern and ergonomic design is known for its performance and efficiency. It produces up to 8 hours of constant and uniform warmth for your feet. It has a drying option for quickly drying insoles after skiing.

### Characteristics:

- 3 warming modes for perfect warmth
- Dries the insoles
- 8-hour battery life
- Easy to clip on
- Lithium-ion battery
- 100 - 240 V / 50 - 60 Hz
- Universal charger (connector for use in EU/USA/GB)
- 2-year warranty (via Internet registration)



HEONE3IN13 ONE3 (UK/US/EU)  
HEONE3EU12 = ONE3 EU  
HEONE3US12 = ONE3 US  
HEONE3UK12 = ONE3 UK

## ONE<sup>3</sup>



This compact and solid battery provides up to 6 hours of warmth with the press of a button. It is easy to use and has three warming modes to bring your feet the gentle and constant warmth that they need.

### Characteristics:

- 3 warming modes for perfect warmth
- 6 hour battery life
- Easy to clip on
- Lithium-ion battery
- 100 - 240 V / 50 - 60 Hz
- Delivered with a universal charger (connector for use in EU/USA/GB) or specific charger per country (see codes below).
- 2-year warranty (via Internet registration)



# SETS = BATTERIES + INSOLES

## PRO SET

HEPROSET12

### The Ultimate package.

All-in-one set comprising:

- 2 PRO batteries
- 1 universal charger
- 1 pair of Heating elements and covers.



8  
HOURS



## ONE<sup>3</sup> SET VOLCANO

EUR only: HEONE3SETVOL13

### All-in-one set comprising:

- 2 "One<sup>3</sup>" batteries
- 1 universal charger
- 1 pair of Volcano H.

Sizes: XS - XXL



6  
HOURS



## ACCESSORIES



### Clip Fix

HECLIPFIX

Metal battery clip adapted to all types of shoes.



### Extension cord 80 cm

HEEXTCORD

Pair of extension cords 80 cm.

### Extension cord 120 cm

HEEXTCORD1

Pair of extension cords 120 cm.



### Sticker

HESTICKREV

After Sales Service tool (if issued with the pack) which checks if the heat is functioning correctly.



### Full Strap

HEFULLSTRAP

Elastic velcro strap to attach the batteries for use during multiple activities.

# SOCKS & ON SKIN



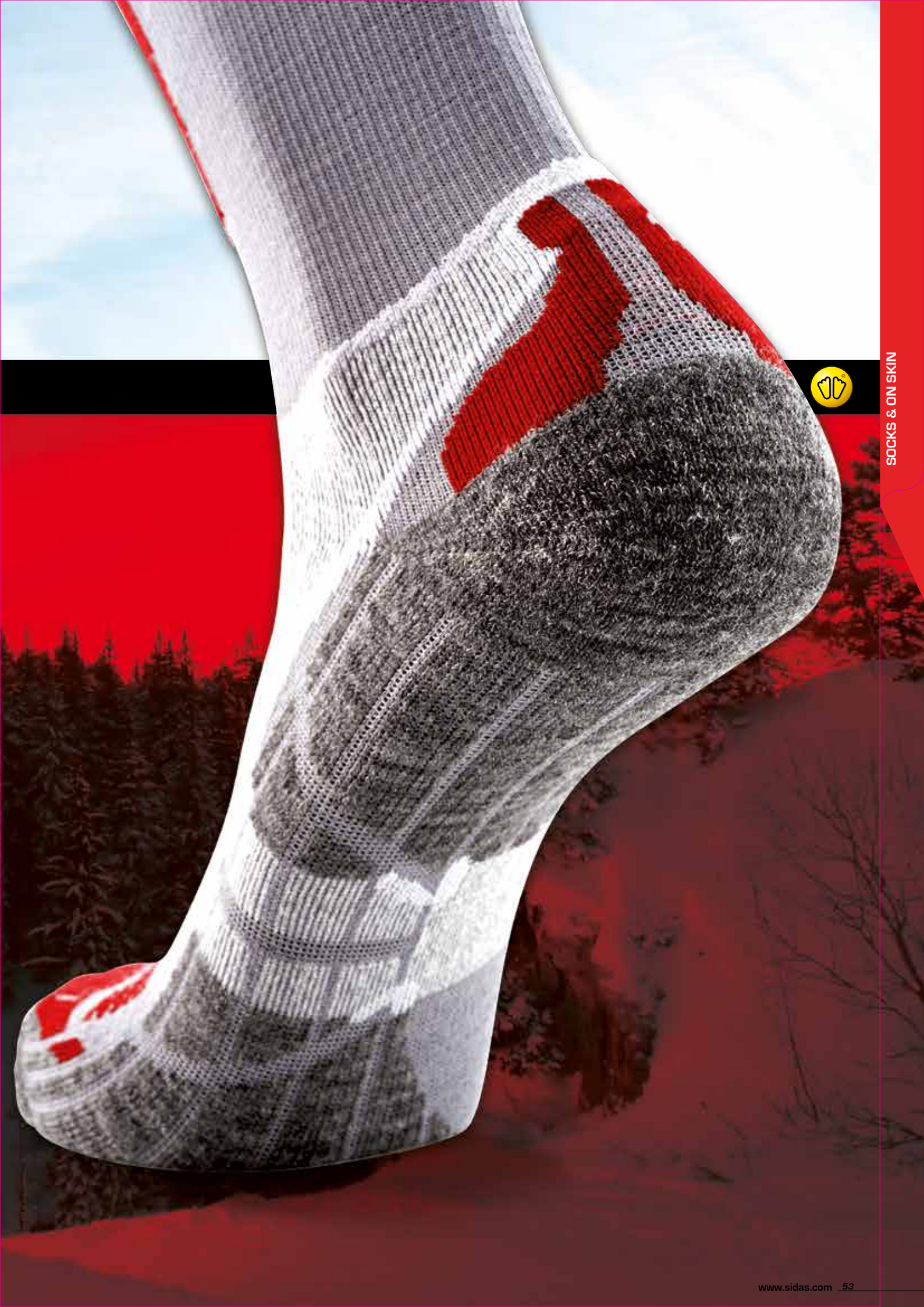

SOCKS & ON SKIN

# SOCKS

## ULTRATHIN

ASOULTRATHIN14

### The thinnest ski socks around.

Designed for skiers looking for high performance, these ultra thin socks transmit sensations directly between skier and boot. The thinness of the fibre and mesh and the semi synthetic materials used provide comfort and thermal regulation in all situations. Combined with a top of the range boot system (insole and liner), these Ultrathin socks make it feel like you are skiing in bare feet.

Sizes: 35-38, 39-41, 42-44, 45-47

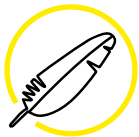

Lightness

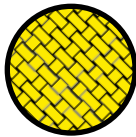

Thinness



Compression



Characteristics	Advantages	Benefits
Lightness	Very light socks	Ideal for skiers looking for an enhanced feeling
Thinness	Innovative 380-needle weave technology	A second-skin effect, provided by their unrivalled lightness
Compression	Compression socks that boost venous return and reduce muscle vibration	Improves performance



## PROTECTIVE GEL

ASOPROTGEL14

### The first socks to feature an integrated gel shin protector.

Designed for skiers looking for shock-absorbing qualities and keen to make shin pain a thing of the past, these socks incorporate a gel protector. They contain technical fibres that regulate temperature and wick away perspiration.

These protective gel socks provide comfort and protection, enabling you to enjoy each day's skiing to the full.

**Sizes:** 35-38, 39-41, 42-44, 45-47

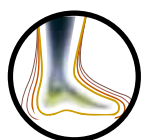

Comfort



GEL  
shin padding



Anatomical  
shape



Characteristics	Advantages	Benefits
<b>Silitene™ gel insert</b> <span style="float: right;">1</span>	Protects the shin	Absorbs shocks and improves comfort
<b>Air-conditioning channels</b> <span style="float: right;">2</span>	Regulates the temperature under the arch of the foot	The ideal temperature in all conditions
<b>Different weaves on the ankle and arch</b> <span style="float: right;">3</span>	Supports the sensitive parts of the foot	- Stabilises the foot within the ski boot - Comfort

# SOCKS

## PERFORMANCE

AXSSKOPERF

### The benchmark performance ski socks.

Designed for athletic skiers, these socks provide the right balance of comfort, performance and foot support. Their semi-synthetic fibre composition provides both good temperature control and moisture transfer.

Sizes: XS, S, M, L, XL, XXL



Anatomical shape



Ventilation channel



Merino wool: warmth



SOCKS & ON SKIN

Characteristics	Advantages	Benefits
Differentiated-weave design <b>1</b>	Supports the sensitive areas of the foot	- Stabilises the foot inside the sock - Improves comfort
Ventilation system <b>2</b>	- Regulates heat - Ventilates the foot	Keeps the foot warm and dry, and at the ideal temperature
Shaped anatomically, available in 6 sizes <b>3</b>	Optimum foot-hugging design without creating pressure points	Comfort and performance



# THE WARMEST SOCKS

## PRO HEAT SOCKS

COMPLETE SET: HESOPROHSET14  
 PRO S (BATTERIE PACK ALONE): HESOPROSBP14  
 PRO HEAT SOCKS (ALONE): HESOPROHEAT14

The first Sidas socks to incorporate a heating system.

Designed especially for skiers who have problems with cold feet, our Pro Heat socks incorporate a heating element and lithium-ion battery. They contain natural wool combined with technical fibres that regulate temperature and wick away perspiration effectively. Pro Heat socks provide the comfort and warmth required to cope with even the harshest weather conditions. The revolutionary material XITANIT® features highly conductive properties and is able to reflect radiated heat.

Sizes: 35-38, 39-41, 42-44, 45-47



Xitanit®

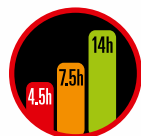

3 heating modes



Anatomical shape



Characteristics	Advantages	Benefits
<b>2400mAh lithium-ion battery</b> <span style="float: right;">1</span>	3 heating settings that diffuse heat directly underneath the foot. Battery life of up to 14 hours	Gentle, constant and even heat for perfect thermal comfort in all conditions
<b>Compact battery integrated into the sock</b> <span style="float: right;">2</span>	The compact battery has a sock-clip system	- Easy to use - Easy sock washing
<b>Xitanit®</b> <span style="float: right;">3</span>	This metal-like material boosts heat conductivity	Channels heat to the inside of the foot to maintain a perfect temperature

# 3FEET® SOCKS

Winter 3Feet® socks are suitable for all foot types. They are tailored to the shape of high / mid / low arched feet.



AXS3FW12-HI

## WINTER 3FEET® HIGH



Specifically designed for high arch feet. Internal shin reinforcement for maximum comfort. Compression socks.

**Sizes:** 39-41, 42-44, 45-47

1. Cushioning at the pressure points of the HIGH foot
2. Stretchable and thin fabric adapted to the HIGH foot
3. Shin pad adapted to the HIGH foot movement (supination)
4. Compression zone: improves circulation, optimises performance



Anatomical shape



X-SOCKS™ Technology™



Compression



HIGH ARCH

## WINTER 3FEET® MID

AXS3FW12-MI



Specifically designed for medium arch feet. Shin reinforcement for maximum comfort. Compression socks.

**Sizes:** 35-38, 39-41, 42-44, 45-47

1. Anatomic sole adapted to the shape of the Mid foot
2. A small amount of padding to prevent friction and ensure comfort
3. Shin pad for optimal comfort
4. Compression zone: improves circulation, optimises performance



Anatomical shape



X-SOCKS™ Technology™



Compression



MID ARCH

## WINTER 3FEET® LOW

AXS3FW12-LO



Specifically designed for low arch feet. External shin reinforcement for maximum comfort. Compression socks.

**Sizes:** 35-38, 39-41, 42-44, 45-47

1. Uniform padding adapted to the pressure of the LOW foot
2. Padding designed for the LOW foot, to enhance footwear fit
3. Shin pad adapted to low foot movement (pronation)
4. Compression zone: improves circulation, optimises performance



Anatomical shape



X-SOCKS™ Technology™



Compression



LOW ARCH

# MARKETING & COMMUNICATION



## Ultra Thin POS

ASOMKULTHINPOS14

Marketing tool featuring a black demo foot and an Ultra Thin sock.



## Protective Gel POS

ASOMKPROTGELPOS14

Marketing tool featuring a black demo foot and a Protective Gel sock.



## Pro Heat POS

HESOMKPROHPOS14

Marketing tool featuring a black demo foot and a Pro Heat sock (without battery).



## Maxi Display

CMK3DDISPL12

Max. capacity: 120 packs, 60 on each side.  
Order separately : 2 facing / 2 POP  
Can include a Feet Revelator™.  
Can also be used on one side only.  
Dimensions: 75 x 160 x 60 cm.



## Black demo foot

CMKKFPSF12

Black plastic foot for in-store sock display.  
The essential tool for your sock aisle.



## 3Feet® foot guide

CMKFOOTGUIDE13  
FR/EN/DE/IT/ES

Guide presenting the 3Feet® concept and the sandals' selling points.  
Supplied in packs of 50 for placing in store next to the sandals or on a counter top.

## 3Feet® WINTER Facing

CMK3FWIFAC12\_MU

## 3Feet® WINTER Pop

CMK3FWIPOP12\_MU

# ON SKIN



Silitene™ Gel material developed by Sidas.  
Material that can be washed in water and reused. It stays in place on the shin and can be cut to size.



Washable



Silitene™



Reusable



NEW  
2016  
2017

## SHIN PROTECTORS

ASKINSHINPROTXL16

### New larger shin protectors for maximum comfort.

The shin protectors are supplied in pairs and are specially shaped to fit the shin. They effectively relieve pain caused by pressure on the shins from ski boots. Placed underneath the sock, these protectors stay firmly in place throughout any sporting activity.

- Varying-thickness gel: 2 mm at the edges and 4 mm in the middle, for improved protection.
- Re-usable.
- Hand-washable with household detergent for a better hold.

**Dimensions:** 150 x 105 mm

Supplied in 20s in a paperboard box that also serves as the in-store display unit.



x2



**PROGRESSIVE GEL  
MAXI SIZE**

NEW  
2016  
2017

## ANKLE PROTECTORS

ASKINANLEPROT16

### New Silitene™ protectors specially designed to fit round the ankle.

They effectively relieve pain caused by the boots pressing against and rubbing the inside and outside of the ankle. Placed underneath the sock, these protectors stay firmly in place throughout any sporting activity.

- Varying-thickness gel: 2 mm at the edges and 4 mm in the middle, for improved protection.
- Re-usable.
- Hand-washable with household detergent for a better hold.

**Dimensions:** 50 mm diameter

Supplied in 20s in a box that also serves as the in-store display unit.



x4



**PROGRESSIVE GEL**

## MARKETING



### On Skin Counter Display

ASKINMKOSCOUNTDISP

New rotating counter display, for presenting the entire On Skin range. Can hold up to 80 small packs (Toe & Foot protector, Protection Kit), and 20 large packs (Foot protector sheet).



### On Skin Box

New-design On Skin range box that can also be used as a display. All On Skin products are supplied in 20s in this box.



BOOTWEAR

# BOOTWEAR







BOOTWEAR

# SHELLS

## S-RX W

CCQRX110WLV



### Comfort combined with precision.

This exclusive SIDAS shell is suited to female skiers with narrow feet and combines performance and precision. Coupled with a PU boot liner it is both aggressive and precise. Coupled with a 100% thermoformable boot liner it offers unmatched comfort. The Sidas booster strap allows unmatched progression and aggression when chaining turns.

**Weight:** 3.090 kg (pair in size 24.5)

**Flex index:** 110

**Width :** 97 mm

**Sizes:** 23.5 to 26.5

Developed in partnership with  **LANGE**  
ULTIMATE CONTROL. FEEL IT

Exclusive sale in France, Italy, Switzerland, Germany, Austria and the United Kingdom  
Supplied with a Sidas Booster™ strap

## S-PRO W

CCQXPROW



### Comfort combined with support.

These top-of-the-range boots are ideal for skilled female skiers. The Twinframe technology ensures excellent rigidity for optimum support. The Sidas booster strap ensures optimum hold of the upper cuff and tongue and easy tightening.

**Weight:** 2.980 kg (pair in size 24.5)

**Flex index:** 90

**Last:** 100 mm

**Sizes:** 23.5 to 26.5

Developed in partnership with  **SALOMON**

Supplied with a Sidas Booster™ strap

All Sidas shells include the Sidas Booster™ Strap!





## VECTOR 120 V2

CCQVECTOR120V2

**Comfort and Performance.**

The Vector 120 V2 is a top-of-the-range ski boot for good to expert-level skiers which features a concentration of technology designed for comfort, support and results. It has a generous volume and a width of 103 mm. Its flex index of 120 provides the optimum reactivity required for top-level skiing performance. Its triple-injection PU construction and buckles with micrometric adjustment provide perfect foot support.

The Sidas booster strap ensures optimum hold of the upper cuff and tongue and easy tightening.

**Weight:** 3.850 kg (pair in size 26.5)

**Flex index:** 120

**Width :** 103 mm

**Sizes:** 24.5 to 30.5



Developed in partnership with HEAD  
Supplied with a Sidas Booster™ strap

## CX MAX

CCQXMAX

**Performance and Precision.**

A top-of-the-range ski boot for very good skiers that incorporates Twin Frame technology to provide the rigidity you need for greater control and enhanced responsiveness. This is combined with an unrivalled foot-hugging fit for optimum performance on the piste. PU bi-material lower shell and upper cuff construction.

The 24mm oversized pivot reduces the interaction between the lower shell and cuff for outstanding precision and direct power transmission.

The angles have been modified to optimise the foot position and provide better heel hold for increased precision.

The Sidas Booster Strap ensures optimum hold of the upper cuff and tongue as well as easy tightening.

**Weight:** 3.400 kg (pair in size 26.5)

**Flex index:** 120

**Last:** 98 mm

**Sizes:** 24.5 to 29.5



Developed in partnership with SALOMON  
Supplied with a Sidas Booster™ strap

## CX PRO

CCQXPRO

**Comfort and Performance.**

A ski boot for good skiers that incorporates Twin Frame technology to provide the rigidity you need for greater control and enhanced responsiveness.

This is combined with an unrivalled foot-hugging fit for optimum performance on the piste. PU bi-material lower shell and upper cuff construction.

The Sidas Booster Strap ensures optimum hold of the upper cuff and tongue as well as easy tightening.

The 24mm oversized pivot reduces the interaction between the lower shell and cuff for outstanding precision and direct power transmission.

The angles have been modified to optimise the foot position and provide better heel hold for increased precision.

**Weight:** 3.445 kg (pair in size 26.5)

**Flex index:** 100

**Last :** 100 mm

**Sizes:** 24.5 to 29.5



Developed in partnership with SALOMON  
Supplied with a Sidas Booster™ strap

# PU INNERBOOTS

## PU CLASSIC COMFORT

CCHPUCLACOMF



The PU Classic Comfort boot liner is a premium customization solution for a perfect fit and optimum comfort.

The micro fur interior provides softness and warmth and ensures easy foot entry.

The new upper cuff structure provides a better torsion-comfort ratio.

Skiers will find this boot liner comfortable and attractive, while boot fitters will find it both safe, and easy to inject.

**Sizes:** C - L

1. Pullstraps: **EASY FOOT ENTRY**
2. PU carbon structure: **FLEXIBILITY & DESIGN**
3. Micro fur interior: **SOFTNESS, WARMTH & EASY FOOT ENTRY**
4. Pre-shaped injection pocket: **INITIAL FIT & EASE OF INJECTION**
5. Laces: **GOOD FOOT SUPPORT**



## PU CLASSIC FLEX W

CCHPUCLAFW15



The Classic Flex Women boot liner, developed for the needs of female skiers, combines comfort and precision.

The form and the new materials used (e.g. micro-fur) ensure softness, flexibility, elasticity and overall comfort.

The design of these boot liners is ideal for the Sidas shells created especially for female skiers.

**Sizes:** D - G

1. Pull straps for easier handling
2. Broader tongue for maximum comfort
3. Laces for superior foot support
4. Elasticated clip for heating cable
5. Leather-look bags (PU)

## PU CLASSIC V2 BS

CCHPUCLASVZBS



The PU Classic V2 has been modified to meet the performance and accuracy requirements of good skiers even more effectively.

The liner bags are stitched for better rigidity and improved performance.

The new material inside the liner provides more feeling when out skiing.

**Sizes:** C - L

1. New inner textile: better feeling
2. New top part construction: more flexible
3. New tongue: EVA inside - Tibial cushioning - Thinner velcro - New textile
4. New heel shape: comfort
5. New outsole: stiffer to keep dimensions

PU TRANSFOAM FLEX

CCHPUTRAFLEX



This 'Flex' material has the same properties as Transfoam but offers more flexibility, stretchability and comfort. For technical skiers looking for a simpler injection process and a tolerant liner that doesn't affect shell rigidity. Transfoam technology features sealed bags that reduce leakage.

Sizes: C - M

1. Broader tongue for maximum comfort
2. Pull straps for easier handling
3. Broader, adaptable top section
4. Laces for superior foot support
5. Elasticated clip for heating cable
6. Adaptable forefoot width
7. Neoprene toe box

LINER TOOLS

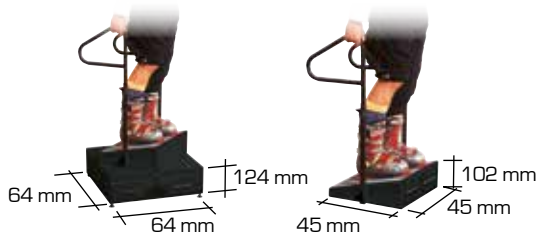

**Foam podium**  
CCHCHPOD

The ultimate foaming station with adjustable handles, 2 drawers, and a rotation device to facilitate the foaming process.

**Mini foam podium**  
CCHCHPOD2T

Podium to foam PU liners with drawers.



**Foam tongue**  
CCHDCLAFD09

A totally new foam tongue, that combines a highly curved shape with the foaming process: give it a try and you will feel the difference.



**Ready-to-fit tongue V2**  
CCHDCLARTV2

A new ready-to-fit tongue V2, with a highly curved shape to fit snugly against the foot and enable maximum transmission power, and a unique design to provide a perfect progressive flex.



**Foam tongue strap**  
CCHACFTSTRAP

The strap enables you to tighten the foam tongue against the shin, in order to control the foam flow.

**3D Toe caps**  
CCHACTOECAP3D - 2 sizes  
CCHACTOECAP3DX3 - 3 sizes (T1 / TM / T2)



**PU down-grading kit**  
CCHACPUJGRDKIT - box of 10

A dropper for obtaining a smaller dose of Isocyanate for a more flexible foam.



**Adhesive pad**  
CCHACCAL  
CCHACADH5-15 - Adhesive pads 5-15  
CCHACADH2-50 - Adhesive pads 2-50

Pack of 10.



**PU BS foam kit**  
CCHACDOSSFT1P

PU INNERBOOT PROCESS

Process:





# 100% THERMOFORMABLE INNERBOOTS

## CENTRAL WOMAN

CCHCFCENTW15



This new, fully thermoformable boot liner is designed for female skiers requiring comfort and warmth. This boot liner is also available in the warming version (see page 68)

Sizes: D - G

1. Synthetic sheath lining: **COMFORT and WARMTH**
2. Tailored to the female anatomy: more open and more flexible upper cuff. **OPTIMUM COMFORT and SENSITIVITY**
3. Central tongue for maximum precision
4. Laces for improved foot support
5. Flat insole for easier moulding



## CENTRAL WOMAN H

CCHCFCENTWOH13  
(WITHOUT BATTERY PACK)



**A liner for women.** This liner was developed especially for women, as such it features a high, open collar with greater flexibility. By perfectly fitting the anatomy of the female foot it provides optimal comfort and sensitivity.

**Integrated warming system.** This is the warmest boot liner in the world, firstly because it is made entirely of EVA, which provides excellent thermal insulation.

In addition to its insulating construction it incorporates heating elements connected to a battery that produces gentle, constant warmth for up to 8 hours. This is on the outside of the boot liner, making it easily accessible whilst skiing.

Sizes MP: D - G

1. Synthetic sheath lining: **COMFORT and WARMTH**
2. Tailored to the female anatomy: more open and more flexible upper cuff. **OPTIMUM COMFORT and SENSITIVITY**
3. Integrated Sidas heating elements: produce a gentle, constant warmth for **OPTIMUM THERMAL WELL-BEING**.  
**Can be used with the Pro or One<sup>2</sup> battery.** Liner supplied on its own (order batteries separately).
4. Central tongue for maximum precision
5. Laces for improved foot support
6. Flat insole for easier moulding
7. Optimised, integrated heating cable



# 100% THERMOFORMABLE INNERBOOTS

## CENTRAL HIGH V3

CCHCFCENTHIV3



Fully thermoformable. Provides maximum comfort and precision. Designed for alpine skiing and ski touring (high boots with 4 buckles). With its new internal design in black micro-fur the boot liner offers skiers softness and comfort.

Sizes: F - K

1. New tongue stiffness with reinforcement: precision
2. New microfleece inner textile: easier to step in & long lasting
3. New ankle shape: comfort
4. New flex zone: comfort and precision
5. New toebox thickness: easier for thermo moulding
6. Openings on the upper cuff for more suppleness when skiing

## CENTRAL HIGH SLIM

CCHCFCENTHISL 13



### The slimmest thermoformed boot liner.

This boot liner is designed for alpine skiing and ski touring (high boots with 4 buckles). With its 5mm EVA foam structure, this liner will fit even the narrowest boot shells. It has been developed with a new Ultralon foam, which is even softer and more precise.

Sizes: D - K

1. EVA foam thermo 5mm: slim Version for low volume ski boot, and precision
2. Tongue: stiffness for better precision
3. New foam: comfort and precision
4. Outsole: 3mm. Easier moulding for low volume boots

## LINER TOOLS



↑	450 mm
→	400 mm
↘	580 mm
📦	15 kg
⚡	110V/220V



**Adhesive roll**  
Reinforced - CCHACS50  
Soft - CCHACS15



**3D Toe caps**  
CCHACTOECAP3D - 2 sizes  
CCHACTOECAP3DX3 - 3 sizes (T1 / TM / T2)



### Adhesive pad

CCHACCAL  
CCHACADH5-15 - Adhesive pads 5-15  
CCHACADH2-50 - Adhesive pads 2-50

Pack of 10.



See page 100 for all Sidas training

## THERMO INNERBOOT PROCESS

Process:

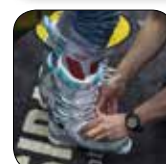

# EXAMPLES OF COMBINATIONS

The combination examples are just some of the many assembly options available. Keep innovating and creating your own combinations!

## FULL THERMO S-MAX

CCSFUTHSMAX15



**Performance and Precision.**

This top-of-the-range boot will appeal to all skiers looking for a high-performance, comfortable and durable product. It consists of a 100% thermoformable Sidas boot liner for more comfort and warmth, a top-of-the-range customisable shell for optimum support and a Sidas booster strap for greater flexibility. A 3D insole provides extra comfort and precision.

**Weight:** 4.020 kg (pair in size 26.5)

**Flex index:** 120

**Width :** 98 mm

**Sizes:** 25.5 to 29.5



## FULL THERMO S-PRO

CCSFUTHSPRO15



**Comfort and Performance.**

This top-of-the-range boot will appeal to all skiers looking for a high-performance, comfortable and durable product. It consists of a 100% thermoformable Sidas boot liner for more comfort and warmth, a top-of-the-range customisable shell for optimum support and a Sidas booster strap for greater flexibility. A 3D insole provides extra comfort and precision.

**Weight:** 4.080 kg (pair in size 26.5)

**Flex index:** 100

**Width :** 100 mm

**Sizes:** 25.5 to 29.5





FULL THERMO S-PRO W

CCSFUTHSPROW15



**Comfort and Support.**

This top-of-the-range boot will appeal to all female skiers looking for a comfortable, warm and durable product that does not compromise on performance. It consists of a 100% thermoformable Sidas boot liner for more comfort and warmth, a top-of-the-range customisable shell for optimum support and a Sidas booster strap for greater flexibility. A 3D insole provides extra comfort and precision.

**Weight:** 3.640 kg (pair in size 24.5)

**Flex index:** 90

**Width :** 100 mm

**Sizes:** 23.5 to 26.5



+



FULL THERMO S-RX W

CCSFUTHSRXW15



**Comfort and Warmth.**

This top-of-the-range boot will appeal to all female skiers looking for a comfortable, warm and durable product that does not compromise on performance. It consists of a 100% thermoformable Sidas boot liner for more comfort and warmth, a top-of-the-range customisable shell for optimum support and a Sidas booster strap for greater flexibility. A 3D insole provides extra comfort and precision.

**Weight:** 3.750 kg (pair in size 24.5)

**Flex index:** 110

**Width :** 97 mm

**Sizes:** 23.5 to 26.5

Exclusive sale in France, Italy, Switzerland, Germany, Austria and the United Kingdom



+



# HEATED SKI BOOTS

This new rental product is set to revolutionise skiing for skiers who feel the cold! These heated ski boots will enable your customers to stay warm whatever the weather. The heating system built into the liner gives out constant heat for a full day's use.



## RENTAL HEAT SKIBOOTHS H

CCSRENHEATW15



Sizes: 25.5 to 29.5



**INTEGRATED BATTERY**

## RENTAL HEAT SKIBOOTHS W

CCSRENHEATW15



Sizes: 23,5 à 26,5



**EASY TO CHARGE**

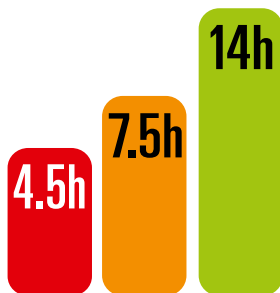

**3 HEATING LEVELS**



**DELIVERED WITH 3D RENTAL INSOLES**



**EASY TO USE**

## Increase your profitability

- Minimum 20 pairs.
- Supplied with chargers.
- Generates spin-off sales of heated products.

## Stand out from the crowd

- Enhances the reputation of your sales outlet within the resort.
- Broadens your rental offering.
- High-quality ski boots developed exclusively for rental (better quality plastic): guaranteed for 2 years.
- Sidas - Salomon - Thermic components ensure expertise.

## User-friendly

- Battery built in to the liner.
- Easy to recharge all pairs.
- Supplied with a charger for the customer's use (for those who want to recharge their boots where they are staying).

## Effective communication

- Communication by Sidas in the resort and on websites.
- Promotion of your offering using powerful communication tools:
  - Banner ads provided for your communication.
  - Floor stickers.
  - Window display poster.
  - POS advertising with place to add day-rental price.

### RENTAL COMMUNICATION KIT

CCSRENMKCOMKIT

English - French

English - German

### RENTAL HEAT POS

CCSREMPLVHEAT

POS with leds



x1 Poster: 60 x 80 cm



Banner ads



Floor stickers: 95 x 270 mm x5



POS advertising: 160 x 220 mm x2





# BOOT & SHOE ACCESSORIES



BOOT & SHOE  
ACCESSORIES



S



BOOT & SHOE  
ACCESSORIES



# WALK TRACTION

## GRIP SNOW AND ICE

- Anatomically constructed to facilitate the forward flexing movement of each foot (right and left).
- End studs for superior grip.
- Wider stud base for long-lasting hold.
- Thick, hard-wearing rubber, as used in the motor industry, for a better hold on the foot.
- Shaped at the heel for a better fit.
- Stainless steel stud tips.
- Textured interior webbing for improved grip onto footwear.
- PPE (Personal Protection Equipment)-certified by the CTC.
- Each pair comes with two spare studs.



Tested and approved by **Maurice Manificat**, second in the world cross-country ski world cup.



ASYMMETRIC  
CONSTRUCTION







**WALK TRACTION<sup>1/2</sup>**

CTRWALKHALF16

The Walk Traction 1/2 system is the best way to stay safe when walking on snow and frozen ground.

- Small grip for city shoes.
- One size.
- Easy to put on.



**WALK TRACTION**

CTRWALK16

The Walk Traction system is the best way to stay safe when walking on snow and frozen ground.

- Anatomically constructed to facilitate the forward flexing movement of each foot.
- Easy to put on.
- 4 sizes for a perfect fit.

Sizes: S - M - L - XL



**MARKETING & ACCESSORIES**



**Traction small display**  
CTRMKSMLDISPL16

A slim display unit that you can place behind the checkout or for cross merchandising in the footwear department. It can accommodate 4 Traction products.



**Small black pocket BAG**  
ASACBLKPOCKBAG16

Pack of 10.



**Traction carton display**  
CTRMKCARTDISPL16 (EMPTY)

Paperboard display unit supplied assembled. Easy to move around the store. Can accommodate 20 Traction 1/2 & 40 Traction, or 60 Traction. Two options:  
- Supplied without products  
- Supplied assembled with a set of products ready for sale.



**Spare Spikes**  
CTRSPSPIKES16

x 30.



**Column display**  
CMKPVTOURDIS15

The column display is a rotating display stand featuring:  
- 8 perforated sides  
- 5 castors, 2 of which have brakes  
- 1 platform for attaching a demonstration foot.  
Dimensions: 180 x 55 cm.

# SKI BOOTS POWERSTRAP



The Sidas Booster™ Strap is an essential accessory for improving ski boot performance.

When used correctly, it ensures excellent control of the skis, improves comfort and helps prevent shin pain. It eliminates empty space between the shin and the ski boot tongue. The Sidas Booster™ Straps are supplied with 4 screws and 4 grip inserts.



The Sidas Booster™ Straps are supplied with 4 screws and 4 grip inserts.



**Powerstrap women\***  
CCHACBOOSIDW15

Booster™ light for intermediate level.



**Powerstrap men\***  
CCHACBOOSIDW15

Booster™ medium for intermediate level.

\*Not to be sold in North America (USA and Canada)

# DRYING AND HEATING

## DRYWARMER

HEDRYW230EU12 = DRYWARMER EUROPE  
HEDRYW230UK12 = DRYWARMER US  
HEDRYW110US12 = DRYWARMER UK

### Drying combined with cleaning.

Heats to a temperature that is high enough to dry and warm all types of shoes. The UV has an antibacterial action. The pack includes a DRYWARMER for a pair of shoes.



## HOTDRYER

HEHOTDRSET12

The Hotdryer is a warming and drying appliance for shoes and gloves which can be plugged into the cigarette lighter in your car (12V).

It is compact and specially designed to be inserted deep inside shoes or gloves.

This technology blows warm air thanks to its two efficient blowers.

Ideal for skiing: it allows you to warm up your shoes and gloves before skiing and to dry them out during your journey home.

Can also dry and warm all other types of shoes.





# BUCKLES



## CUSTOM FLAG BUCKLES

CCQBKFLAG14\_+ NAME OF THE COUNTRY

**Racing quality: premium aluminium alloy 60/60 extruded buckles on steel base.**

- Adapted to fit the X-Max, X-Pro, Impact, X-3 and most other 3 or 4 buckle ski boot shells currently available.
- In addition to providing accurate and efficient hold and support, these buckles allow you to customise the appearance of your boots.
- Suitable for replacing the 2 lower buckles only.

**Made in Italy.**

**Sold in boxes of 5 pairs.**

*These buckles are sold without screws.  
The Buckle installation kit contains everything required to install custom buckles onto ski boots.*



## CUSTOM BUCKLES WITH SHOP LOGO



**New: customise your ski boot buckles with your logo or motto!**

These buckles are ideal for Sidas boots and will fit most other boots on the market.

**Made in Italy.**

**Minimum order: 200 units.**



## BUCKLE INSTALLATION KIT

COUCHBB



**A kit containing everything required to install custom buckles onto skiboats.**

Includes:

- 100 nuts/ 100 screws.
- 1x hex head key.
- 1 drill diam 3/1 drill diam 6.

# BAGS



## FLAG BOOT BAGS

ASACSKIFLAG14\_+ NAME OF THE COUNTRY

### Ultra light skiboot bag.

- Made from water and dirt-resistant fabric and reinforced to protect the contents.
- Top-opening for easy access to your boots.
- Side pocket for storing accessories.
- High quality bag with YKK zip.

### Features:

- Soft bag.
- YKK zip
- 1 front zip pocket.
- 1 side pocket
- 4 plastic reinforcement strips on the underside.
- Composition: tarpaulin and nylon.

**Dimensions:** 40 x 42.5 x 24 cm



## BAGS AVAILABLE:



FRANCE



NETHERLANDS



RASTAFARIAN



RUSSIA



SWITZERLAND



UK



USA

## BOOT BAG YELLOW

ASACSKI13 WITHOUT SHOP LOGO  
ASACSKI13\_ WITH SHOP LOGO



The Sidas Boot Bag is an ultra-light bag designed to hold one pair of ski boots. It is made from water and dirt-resistant fabric and reinforced to protect the contents. It opens at the top for easy access to your boots. It also has a side pocket for storing accessories.

Soft bag, 1 front zip pocket, 1 side pocket. 4 plastic reinforcement strips on the underside.

**Dimensions:** 40 x 42.5 x 24 cm

**Composition:** 600 D coated polyester and nylon

### Promotion tool:

your logo printed on the bag.

- Min. 50 units

- Format : 20 x 23 cm



# BAGS

## BOOT BAG WOMEN

ASACSKIBOOTW15 WITHOUT SHOP LOGO  
ASACSKIBOOTW15\_ WITH 1 SIDE SHOP LOGO



The Boot Bag Women is an ultra-light, water and dirt-resistant boot bag, reinforced to protect the contents. The bag opens at the top to allow easier access to gear. The side pocket offers practical storage. The shoulder strap has been reinforced for added comfort when carrying. The bag is easy to carry thanks to its shoulder strap that can be adjusted to each different person.

**Dimensions:** 40 x 42.5 x 24 cm  
**Composition:** 600 D coated polyester and nylon

**Promotion tool:**  
your logo printed on the bag.  
- Min. 50 units  
- Format : 20 x 23 cm



## BOOT BAG BLACK

ASACSKIBOOTBK15 WITHOUT SHOP LOGO  
ASACSKIBOOTBK15\_ WITH 1 SIDE SHOP LOGO



The Boot Bag Black is an ultra-light, water and dirt-resistant boot bag, reinforced to protect the contents. The bag opens at the top to allow easier access to gear. The side pocket offers practical storage. The shoulder strap has been reinforced for added comfort when carrying. The bag is easy to carry thanks to its shoulder strap that can be adjusted to each different person.

**Dimensions:** 40 x 42.5 x 24 cm  
**Composition:** 600 D coated polyester and nylon

**Promotion tool:**  
your logo printed on the bag.  
- Min. 50 units  
- Format : 20 x 23 cm



## SHOE BAG

ASACSHOE14 WITHOUT SHOP LOGO  
ASACSHOE14\_ WITH 1 SIDE SHOP



The Sidas Shoe Bag is a small ultra-light bag for one pair of sports shoes. It is made from a water-resistant and dirt-resistant fabric to protect the contents of the bag. You can give away this small promotional bag will to your clients all the while promoting your shop, thanks to your logo printed on the bag (at least 50 units). You can mark your logo on one side.

**Product characteristics:**

- Soft bag, 1 front pocket with zipper, 4 plastic stays under the bag
- Dimensions: 33 x 25 x 22 cm
- Composition : 600 D coated polyester and nylon





# MARKETING & COMMUNICATION



**Certified bootfitter softshell**  
CMKPVVESTBP12



**Custom Flag POS**  
CMKFLAGBKPOS14

Large POS to introduce all the Custom Made/Custom Look range. Delivered with 1 skiboot (with two Custom Flag buckles). Can include 50 units of buckle packaging (10 x 5) + 3 Flag boot bags. Dimensions: 70 x 180 x 43 cm

10 different hooks (instead of 8 on the picture)



**On the Wall Custom Flag POS**  
CMKFLAGWALPOS14

For display on a skiboot wall or counter. Can include 15 units of buckle packaging. (5 x 3). Delivered with 1 skiboot (with two Custom Flag Buckles). Dimensions: 50 x 46 x 15 cm



**Sidas Shelves**  
CMKHELLWASU

The new Sidas shelves are universal shelves for installation in your stores. They can be used to present both winter and summer products. The shelves can be installed either in an aisle in your store or on a counter top. Delivered in packs of 4. Dimensions: 350 x 210 x 150 cm



**Wall Facing Sidas**  
CMKWALLFACI16

Sidas cross display panel for all brand products. Dimensions: 60 x 20 cm.



**Wall Banner Sidas**  
CMKWALLBANN16

Sidas product wall separators. Dimensions: 30 x 100 mm Supplied in twos.



**Custom Made Custom Look Poster**  
CMKPOSBP12

50 x 70 cm Black Project poster.



**Certified Bootfitter window sticker**  
CMKSTIVINDBF

"Certified Bootfitter" window sticker. Dimensions: 21 x 12 cm.



# IN STORE BOOTFITTING

IN STORE  
BOOTFITTING

**SIDAS**  
Your foot company



IN STORE  
BOOTFITTING





# MAPPING TOOLS

The following Sidas boot-fitting tools are available individually:









## HEAT THE SHELL

<b>Nestor V3</b>		CMALBBL30NES
------------------	---	--------------

## STRETCH THE SHELL TOOLS

<b>Croco Light</b>		COUCHCROLIGHT14
<b>Yeti V2</b>		COUCHYETI14







## STRETCH THE SHELL TIPS

<b>Variable Arch</b>		COUCHARCH14
<b>Stretching Ring</b>		COUCHRING14
<b>Met Ball</b>		COUCHMETBALL14
<b>Ankle Ball</b>		COUCHANKLE14
<b>Met ogive</b>		COUCHMETOGIV14
<b>Wood Met 1</b>		COUCHWOODMET1
<b>Wood Met 2</b>		COUCHWOODMET2
<b>Jumbo/Jumbo+</b>		COUCHJ-J
<b>Oval tip 67</b>		COUADYOG

## STRETCH THE SHELL TIPS

<b>Round tip 50</b>		COUADYEG
<b>Round tip 35</b>		COUADYEP
<b>Wood tip1</b>		COUCHWOODTIP1
<b>Wood tip2</b>		COUCHWOODTIP2
<b>Wood heel</b>		COUCHWOODHEEL



## ACCESSORIES

<b>Croco Light fix</b>		COUCHFXCROCLHT
<b>Symetric connector</b>		COUCHSYMCON
<b>Extension 28 mm</b>		COUADYPR
<b>Extension 40 mm</b>		COUADYMR
<b>Extension 75 mm</b>		COUADYGR
<b>Washer 3mm</b>		COUADYRO
<b>Stability block</b>		COUCHPONT13

## REVET - UNIREVET - TOOLS

<b>Croco</b>		COUCHCROCO14
--------------	---	--------------

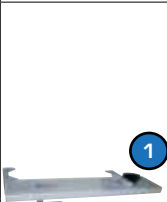
## OPEN THE SHELL

<b>Jack</b>		COUCHJACK
<b>1</b> <b>Boot holder</b>		COUCHSABO
<b>2</b> <b>Tool Clamp</b>		COUCHFIXE
<b>Boot spreader</b>		Avec fixation: COUCHSPREADFIX Sans fixation: COUCHSPREAD

## STORAGE

<b>Travelling Box</b>		COUCHTB
-----------------------	---	---------

# STRETCHING

## KIT DEFORM 75

COUCHKIT75



Experience shows that more than 75% of all shaping carried out by boot fitters is to relieve localised foot pain.

The Deform 75 is the basic kit for stores looking to offer their customers a fast and effective initial boot-fitting service.

Sidas recommends the use of the Heat gun and the Croco light fix with this kit (not included in the kit).

Tools	Characteristics	Advantages	Benefits
<b>Croco light</b> 1	- Aluminium structure - 390 mm deep - Steel screw	- Weight < 2 kg - Allow to access the bottom of the shell - Solidity and facility	- Easy to handle - Possibility to deform the toe zone - Easy deformation
<b>Variable arch</b> 2	- Double shaft - Plates on ball join - 190 mm serif	- Possibility to have 2 push axis - Provides support on differently shaped surfaces - Big space between the push axis and the support surface	- Allows very extensive forefoot deformations - Provides a stable and homogeneous support - Avoids damaging the shell during deformation
<b>Stretching ring</b> 3	Diam: 137 mm	Large support far from push axis	Doesn't mark the shell
<b>Metal connectors</b> 4	- Aluminium structure - Mounted with screw	- Maintains the heat - Easy to mount and dismount	- Give an inside heating of the deformation zone, creating a more precise and quick deformation - Time gain when changing the tips, and keep the rotation of the tips

## KIT DEFORM 75+

COUCHKIT75P

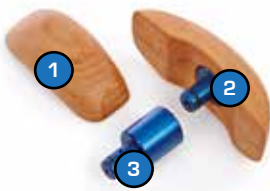

This kit is designed to complement the Deform 75 kit..

It is used for localised shaping of wider boot shells. Used together with the Deform 75 kit, it provides an enhanced solution to customers' localised foot pain problems.

- 1 Wood Met 1
- 2 Wood Met 2
- 3 Extension 28 + symmetric connector

## KIT DEFORM YETI

COUCHKIT75P



Used and approved by boot fitters for more than 10 years, the Yeti and Yeti+ kits have now been combined to create the Deform Yeti kit.

It is suitable for all generalised boot shaping requirements. Designed to complement the Deform 75 and Deform 75+ kits, it is suitable for all boot shell-shaping requirements.

# ANALYSE AND OPEN

## BOOTFITTING SERVICE

CMALBBFSERV15



The Bootfitting Service is a working and storage unit that allows you to promote the boot-fitting service in your store. It consists of a work table, a drawer, a storage space for the oven and a space to display messages about your store and bootfitting service.

The Bootfitting Service is for use with Sidas tools such as the Kit Deform 75 or the Kit Deform Yeti.

Unit only - tools to be ordered separately.

**Overall dimensions:** 86 x 63 cm

**Working surface dimensions:** 75 x 54 cm



Developed and made in France

## BOOT SPREADER

With fixation: COUCHSPREADFIX  
Without fixation: COUCHSPREAD

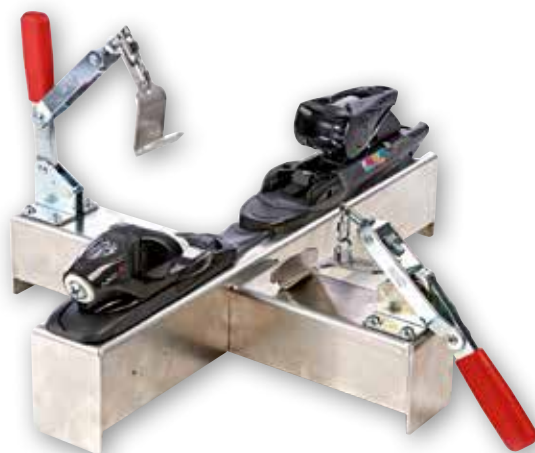

The must-have in-store analysis tool for evaluating the match-up between foot and boot to ensure the right choice of shell is made.

- Aluminium structure.
- Steel handles, length-adjustable to enable the shell to be spread wide.

**Dimensions:** 54 x 43 cm



Process:



# ON SOLE & TONGUE SOLUTIONS

## VOLUME REDUCER

CSEDSRV3 - CSEDSRV5



3 mm

5 mm

This volume-reducer can be placed under a Sidas insole to reduce the fitting room and provide better foot support inside the boot, for superior precision and comfort.

Available in 3mm thickness (high-density) and 5mm thickness (medium-density). Can be trimmed to ensure a better fit inside the boot.

Sold in boxes of 20 pairs.

## HEEL LIFT HARD

CSEACHEELLFT16\_HD\_04 = HEELIFT HARD 4MM  
CSEACHEELLFT16\_HD\_06 = HEELIFT HARD 6MM



Heel insert that goes inside the boot to reduce the volume.  
Sold in packs of 20 pairs.

Heel Lift Hard 4mm  
Heel Lift Hard 6mm



## HEEL LIFT SOFT

CSEACHEELLFT16\_SF\_06 = HEELIFT SOFT 6MM



Heel insert that goes inside the boot to reduce the volume.  
Sold in packs of 20 pairs.

Heel Lift Soft 6mm

## TONGUE SPOILER

CCHACTONGSPO16



The tongue spoiler is used to regulate the volume between the shell interior and tongue.

The spoiler is:  
- pre-shaped;  
- adhesive-coated;  
- grindable;  
- thermoformable;  
- thickness 5 to 10 mm.

Available in 1 size



**Tongue spoiler cover**  
CCHACIPSCOV16-SPO

Pack of 20 units



# WORK ON EXISTING LINERS

## ICP • INNERBOOT PADDING SYSTEM

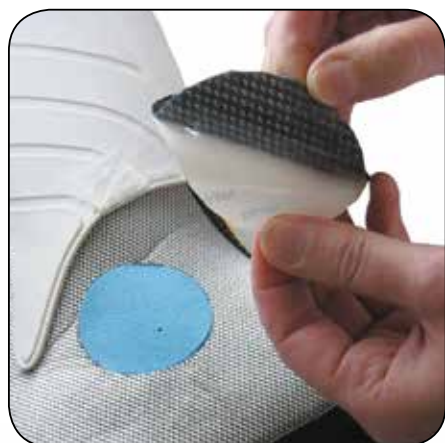

A new way of modifying boot liners to solve skiers' foot problems!

This system involves cutting sections out of the boot liner in the places that are causing the skier pain and replacing these sections with Innerboot Comfort Padding, making the liner more comfortable and quickly relieving pain. Pre-cut elements in several shapes with a protective top layer included: a fast solution for the bootfitter.

Materials used: padding made from Expertène 220 (PU foam) and Ionmesh top layer: advanced materials for an effective, professional solution. New grey top layer with Sidas logos.

*CCHACICP-ROND = 10 ROUNDS*  
*CCHACICP-OVAL = 10 OVALS*  
*P99SCALPEL = SCALPEL + 1 BLADE*  
*P99SCALPLAME = 5 BLADES FOR SCALPEL*



### ICP Kit - CCHACICPKIT

- 1 scalpel
- Oval pads: 4S - 6M - 2L
- Oval toplayers: 4S - 6M - 2L
- Round pads: 2S - 4M - 6L
- Round toplayers: 2S - 4M - 6L



See page 100 for all Sidas training

### ICP PROCESS

Process:

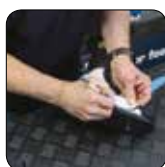
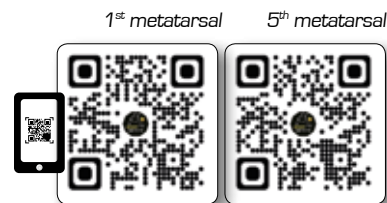

## MARKETING & COMMUNICATION

## TOOLS



### Bootfitting Poster

CMKPOSBOOTFI14

Information poster about Sidas' boot-fitting solutions for in-store display.



### Bootfitting Price Services Poster

CMKBOOTFITPR14

Boot-fitting prices poster for workshop services.



### Travel Box

COUCHTB

Handy toolbox. Comes with removable foam liner which can be adapted to fit tools of all shapes and sizes.

# WORK ON EXISTING LINERS

## IPS • INNERBOOT PADDING SYSTEM

NEW  
2016  
2017



The IPS Kit is a complete set for padding innerboots. The boot-fitter can choose the solution from a range of padding materials.  
Sold in packs of 10 pairs.



*CCHACIPS16-C = IPS C SHAPE  
(PACK OF 10 PCS)  
CCHACIPSCOV16-C = IPS C COVER  
(PACK OF 20 PCS)*

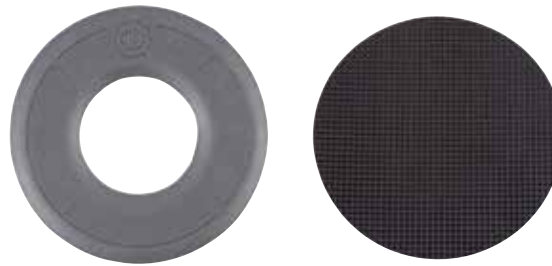

*CCHACIPS16-DON = IPS DONNUT SHAPE  
(PACK OF 10 PCS)  
CCHACIPSCOV16-DON = IPS DONUT COVER  
(PACK OF 20 PCS)*



*CCHACIPS16-V = IPS V SHAPE  
(PACK OF 10 PCS)  
CCHACIPSCOV16-V = IPS V COVER SIZE  
(PACK OF 20 PCS)*



### IPS Kit - CCHACIPSKIT

- 6 double-taped soft foam sheets;
- 4 double-taped hard foam sheets;
- 5 double-taped resin sheets;
- scissors, pen and templates.

### IPS sheet

- CCHACIPSOFT = IPS SOFT FOAM 25*
- CCHACIPSOFT40 = IPS SOFT FOAM 40*
- CCHACIPSHARD = IPS HARD FOAM*
- CCHACIPRESI = IPS RESIN*



See page 100 for all Sidas training

## IPS PROCESS

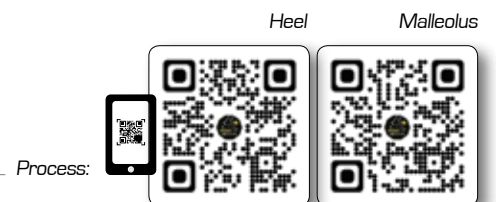



# GRINDERS: BEST SELLERS

## GRAVITY 600

CMATRGRAV600TOT = GRAVITY 600 TOTEM (without equipment)  
 CMATRGRAV600 = GRAVITY 600 (without equipment)

- 1 grinding station and 1 finishing station.
- Expanding wheel.
- Self-locking mandrel.
- Very quiet (< 65 dB).
- Torque: 1.8 Nm.
- Power consumption: 600 W.
- Rotation speed: 2850 rpm.
- LED light.
- Storage shelves.
- The grinding area is completely enclosed, preventing mess and pollution of the working environment.
- Easy to clean.

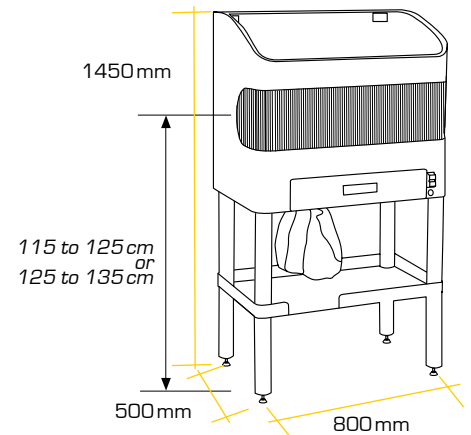

## G1 GRINDER

PPGPONCESEUL

- Double head.
- Expanding wheel.
- Torque 1.5 Nm.
- Motor power: 450 W.
- Power consumption: 450 W.
- Speed of rotation: 2850 r.p.m.

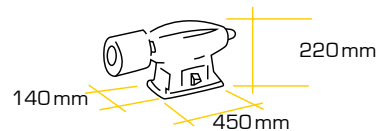

15 kg  
 230V - 50 Hz

## G2 GRINDER

PPGPONCECAR

- Double head.
- Expanding wheel.
- Shielding.
- Torque 1.8 Nm.
- Motor power: 600 W.
- Power consumption: 600 W.
- Speed of rotation: 2850 r.p.m.



Vacuum cleaner attachment point on back of grinder

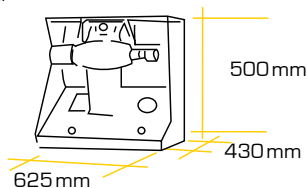

35 kg  
 230V - 50 Hz

# GRINDERS

## G3 GRINDER

PPGUNIPON

- Double head.
- Expanding wheel.
- Shielding.
- Turbine suction.
- Torque 1.9 Nm.
- Motor power: 600 W.
- Power consumption: 1000 W.
- Speed of rotation: 2850 r.p.m.

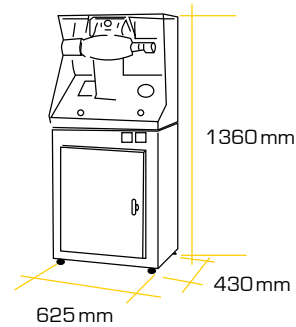

75 kg  
230V - 50 Hz

## G4 GRINDER

PPGTOURG4EVOLUTION

- Expanding wheel.
- Shielding.
- Silent.
- Torque 2 Nm.
- Motor power: 550 W.
- Power consumption: 550 W.
- Speed of rotation: 3000 r.p.m.

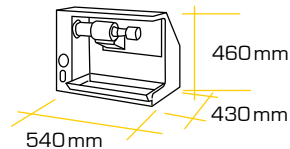

40 kg  
230V - 50 Hz

	Grinding power (Nm)	Ergonomics		Maintenance	Insole finishing	Padding adjustment	Heel Stab adjustment	Liner / boot grinding	Comments
		Space	Dust management						
G1 grinder	1.5	Ultra-compact	Small deflector	Regular cleaning	☆	☆	☆	☆	The ideal tool for introducing boot fitting to your business when you have no space in the workshop
	☆☆☆☆☆	☆☆☆☆☆	☆☆☆☆☆	☆☆☆☆☆					
G2 grinder	1.8	Compact	Open-case frame	Localized cleaning	☆	☆	☆	☆	This grinder deals effectively with dust, allowing you to work efficiently on insoles. Can be combined with an industrial vacuum cleaner
	☆☆☆☆☆	☆☆☆☆☆	☆☆☆☆☆	☆☆☆☆☆					
G3 grinder	1.8	Totem pole structure	Vacuum system	Localized cleaning	☆	☆	☆	☆	G2 vacuum system upgrade reduces tiresome cleaning time
	☆☆☆☆☆	☆☆☆☆☆	☆☆☆☆☆	☆☆☆☆☆					
Gravity 600	1.8	Compact	Closed-case frame	Easy by design	☆	☆	☆	☆	A brand new Sidas product - a perfect combination of performance, appearance and dust management. Can be fitted with a structure to adjust grinder height
	☆☆☆☆☆	☆☆☆☆☆	☆☆☆☆☆	☆☆☆☆☆					
G4 grinder	2	Compact	Open-case frame	Localized cleaning	☆	☆	☆	☆	The grinder for you if your bootfitting creativity has no limits. Can be combined with an industrial vacuum cleaner
	☆☆☆☆☆	☆☆☆☆☆	☆☆☆☆☆	☆☆☆☆☆					

# HEATING TOOLS



IN STORE  
BOOTFITTING

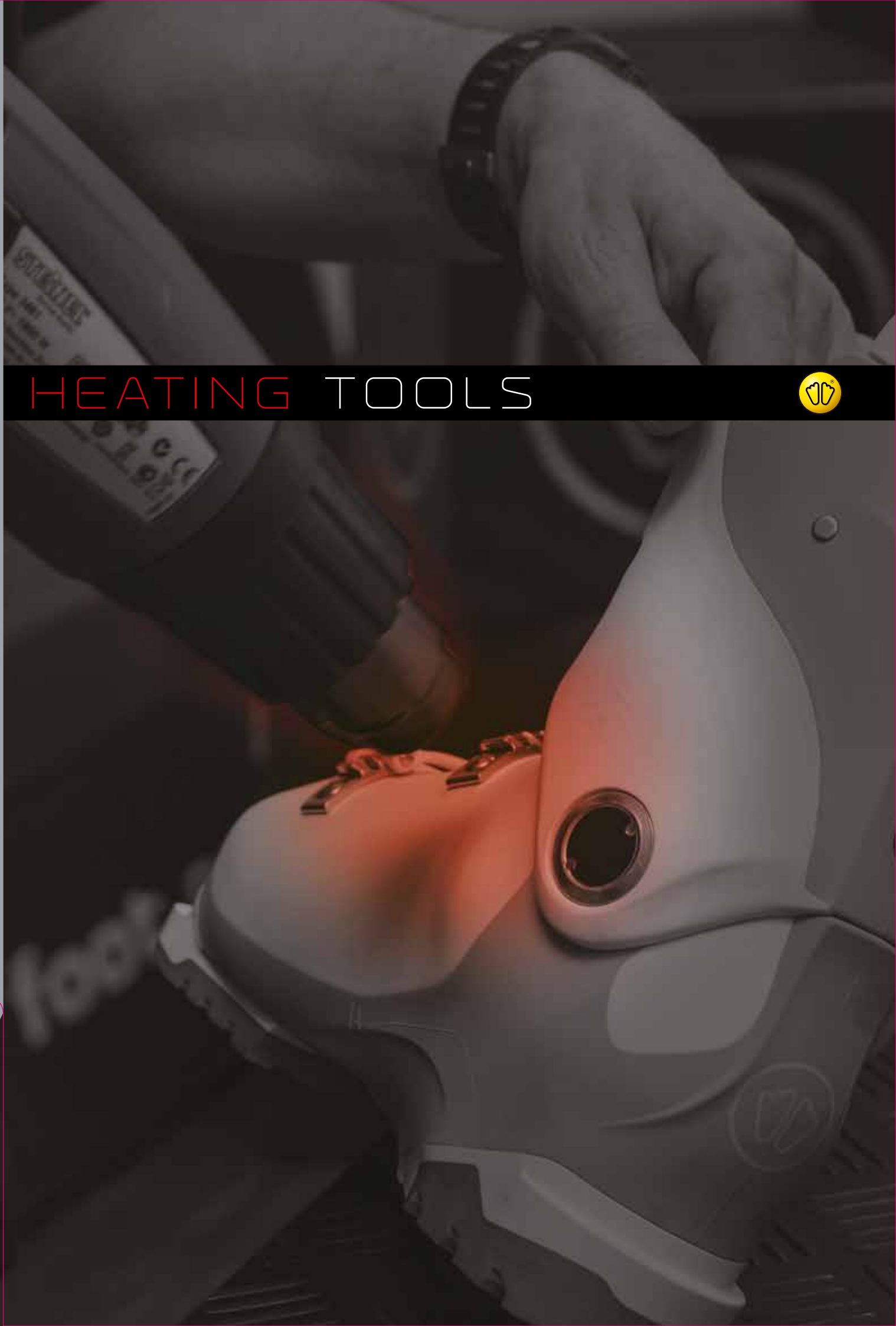



# HEATING TOOLS

## CONFOR'FIT OVEN

COUCHFOU2 - 220V / COUCHFOU1 - 110V



↑ 450mm  
 → 400mm  
 ↘ 580mm  
 15 kg  
 110V/220V

The Confor'fit oven is used to heat thermoformable boot liners (central high, central women, etc.). It is also used to heat ski boots with a thermoplastic shell, including Salomon® models. The Confor'fit oven can be heated to 105°C (variation of + or - 5°C).

## HEAT GUN

COUSESAC



High-quality hot-air gun tested and approved for bootfitting operations (localised heating of the inside and outside of the boot shell, reactivating glue and adhesives, etc.).

## FIT SYSTEM

COUCHFITSYSTEM2 - 220V / COUCHFITSYSTEM1 - 110V



The Fit System heats the boot liner interior so that the thermoformable areas can be heated in a targeted way. Supplied with extension pieces for heating the boot liner to varying degrees in different areas.

### 2 heating programmes:

- 10 minutes
- 15 minutes

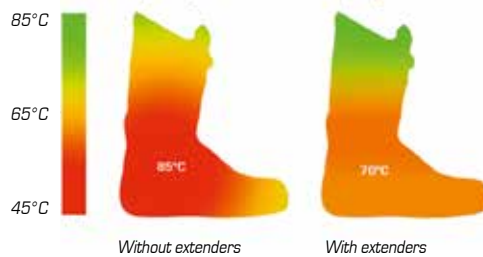

	Temperature (°C)	Heating process	Mobile	Can be left to run	Associated products						Comments
					Glue & Tape	Fitting elements	CustomFit liners	Fullthermo liners	Small areas of shell	All of shell	
Heat Gun	90 - 600	local	☆	☆	☆	☆	☆	☆	☆	☆	The must-have for any boot fitting business
Fit System	80	interior	☆	☆	☆	☆	☆	☆	☆	☆	The perfect system for boot liner heat-shaping. Multiple systems are even more useful
Conforfit Oven	105	interior/exterior	☆	☆	☆	☆	☆	☆	☆	☆	The only tool that heats both liners and shell at the same time



# FOOTWEAR



FOOTWEAR





# THE MOST COMFORTABLE CLOG

FLAT CLOG



X

3D CLOG



STABILITY



X



SUPPORT



X



FOOT-BODY  
ALIGNMENT



X



OK

BOOSTING BLOOD CIRCULATION



The Clog Winter 3D is the ideal partner for boot-fitters, offering unrivalled comfort and excellent foot stability.

Combined with Sidas compressive socks it offers superb comfort throughout the day either when standing or sitting.



# 3D CLOG

## WINTER 3D CLOG

FWSA3DCLOG14

The new 3D Clog specially designed for optimal comfort.

The 3D Clog's shape provides excellent stability and reduces pronation, offering the best compromise between comfort and foot support. The 3D Clog is recommended both for daily use and after sport in order to aid recovery.

Sizes: 36 to 46

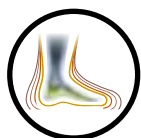

Help recovery



Micro perforated leather



3D shape body alignment

Characteristics	Advantages	Benefits
3D technology 1	3D shape footbed.	- Body and foot alignment. - Stability - Aids recovery after sport
Leather fabric 2	Leather gives quality and flexibility.	- Improves barefoot comfort - Natural aspect
Leather and plastic insole 3	Breathability and adhesion.	- Increased comfort - Dermal stimulation grip - Good foot support
Rubber outsole 4	Grip and durability.	- Long-lasting grip - Cushioning and shock absorption

# TRAINING

## ORANGE LEVEL

STANDARD/ GRADE 1

This training is intended for stores offering the following solutions: 3D, 3Feet®, Flashfit™.

- **Foot Anatomy: knowledge (10%)**  
Foot biomechanics and morphotypes (movement/ pressure/ volume) on Feet Revelator™.
- **Boot Anatomy (10%)**  
Dismantle a boot (lower shell/ cuff/ buckles/ velcro) to know the use of the various parts.
- **Boot sales training (30%)**  
Your customer has a ski boot: you adapt it.  
Your customer is looking for a ski boot: what are the necessary stages for offering the best boot.
- **Training (30%)**
  - Insoles (3Feet®/ 3D/ FlashFit™).
  - Boot liner moulding type "Custom Fit/ Auto Fit..."
  - ICP.
  - Knowledge evaluatio.
- **Problems/ Solutions (20%)**

**Duration: 1 day**

## RED LEVEL

CONFIRMED/ GRADE 2

This training is intended for stores offering the following solutions: Custom insoles, thermoformed boot liners, Kit 75 and Kit Deform.

- **Foot Anatomy: knowledge (10%)**
  - Foot biomechanics and morphotypes (movement/ pressure/ volume) on Podoscope.
  - Analysis using Skier Analyse Station.
- **Boot Anatomy (10%)**  
Boots and the 5 deformation zones.
- **Boot sales training (30%)**  
Your customer has a ski boot: you adapt it.  
Your customer is looking for a ski boot: what are the necessary stages for offering the best boot.
- **Training (40%)**
  - Custom insole moulding (Ski - Ski Pro - Ski Comfort).
  - Thermoformed boot liner moulding.
  - ICP and IPS.
  - Kit 75.
- **Problems/ Solutions (20%)**

**Duration: 2 days**

**Level: Orange minimum**



Trainers selected and trained by Sidas.





# TRAINING

## BLACK LEVEL

ADVANCED/ GRADE 3

This training is intended for stores offering the following solutions: Custom insoles, injected or thermoformed boot liners and shell shaping.

- **Foot Anatomy: knowledge (10%)**
  - Foot biomechanics and morphotypes (movement/ pressure/ volume) on podoscope or Presscam.
  - Analysis using Skier Analyse Station.
- **Boot Anatomy (10%)**
  - Boots and wider deformation zones.
  - Tools to be used as required.
- **Boot sales training (40%)**

Your customer has a ski boot: you adapt it.  
Your customer is looking for a ski boot: what are the necessary stages for offering the best boot.
- **Training (30%)**
  - Foam Liner.
  - Stabilisation and Stab Talon.
  - Custom insole moulding (Ski - Ski Pro - Ski Comfort).
  - Thermoformed boot liner moulding.
- **Problems/ Solutions (10%)**

**Duration: 2 days**  
**Level: Red minimum**

## EXPERT LEVEL

RACING ABILITIES

This training is intended for stores wishing to offer solutions such as a racing offer.

- **Foot Anatomy: knowledge (10%)**
  - Foot biomechanics and morphotypes (movement/ pressure/ volume).
  - Aids to boot sales (Boot spreader + Fit Sticks).
  - Analysis of foot using podoscope (weight distribution).
- **Boot Anatomy (10%)**
  - Boots and wider deformation zones.
  - Tools to be used as required.
- **Boot sales training (30%)**
  - Your customer has a ski boot, you adapt it.
  - Your customer is looking for a ski boot: what are the necessary stages for offering the best boot.
  - Foot analysis on Podoscope (weight distribution).
- **Training (40%)**
  - Thermoformed boot liner moulding.
  - ICP and IPS.
  - Kit 75.
  - Shell Work (Kit 75+ - Kit Yeti - Milling).
  - Insole stabilisation via Stab and/or Cristairs.
  - Foam Liner.
  - Tips and tricks.
- **The market (10%)**
  - Impact of Sidas on the ski market.
  - Market strategy according to the various types of sales areas (large specialised store, specialised store...).
  - Ski market in figures (number of pairs of skis/ global distribution of increase...).

**Duration: 2 days**  
**Level: Black minimum**

## TOOLS



Diploma



Certified bootfitter softshell



Certified Bootfitter window sticker



Anatomical feet



Foot skeleton

# MARKETING & COMMUNICATION

## SIDAS TOOLS



### Small stickers Pack of 10

CMKSTISMAL12

Dimensions: 7 cm x 2.5 cm.

### Big stickers Pack of 10

CMKSTISBIG12



### Shop window sticker

CMKSTIWIND12

Sticker specially designed for shop windows.

Dimensions: 20 cm x 11 cm.



### Carpet

CMKPVTAPI512

Dimensions: 80 cm x 60 cm.



### Carpet corner

CMKPVTAPI5GF

Dimensions: 200 cm x 200 cm.



### Sidas cube

CMKSIDAS\_CUBE12

Dimensions: 0.47 m x 0.47 m.



### Shoe stickers Pack of 20

CMKSTISHOE14

Dimensions: 1.5 cm x 1.5 cm.



### Wall Facing Sidas

CMKWALLFACI16

Sidas cross display panel for all brand products.

Dimensions: 60 x 20 cm.



### Wall Banner Sidas

CMKWALLBANN16

Sidas product wall separators.

Dimensions: 30 x 100 mm  
Supplied in twos.



### Sidas booth

CMKSIDASBOOTH12

Dimensions: 2.25 m x 2.25 m.



### Sidas banner

CMKSIDASBANNER12

Dimensions: 0.80 m x 2 m.



### Flame

CMKPVFLAMSI

Small flag **SIDAS**®.

Delivered with mat and base.  
Dimensions: 2.30 m x 0.60 m.



### Printable Foot sizer

Online tool

## CLOTHES



### Sidas gilet

SIMKGLSIDAS



### Sidas sweat shirt

SIMKSWEATZIP14



### Poster 360°

CMKPOS360

Dimensions: 50 cm x 70 cm.



### Foot Guide 360°

CMKFOOTGF12

### POP for Foot Guide

CMKPOPFOOTG

## DEMO



### DemoBox

CMKKDBSID12



### Insole Demokit for DemoBox

CMKKFKDDB



### Demokit

- WINTER+ CSESPOKWIN12

- WINTER+ Slim CSESPOKWSL12

- WINTER+ COMFORT

CSESPDKWICOMF16

- WINTER 3Feet High

CSE3FDKWH12

- WINTER 3Feet Mid

CSE3FDKWM12

- WINTER 3Feet Low

CSE3FDKWLW12

- WINTER 3D CSE3DDKWIN12

- WINTER 3D COMFORT

CSE3DDKWICOM16

- WINTER 3D COMFORT

WOMEN CSE3DDKWICOMW14

# MARKETING & COMMUNICATION

## DISPLAYS



**Column display**  
CMKPVTOURDIS15

Max. capacity: 120 packs.  
The column display is a rotating display stand featuring:  
- 8 perforated sides  
- 5 castors, 2 of which have brakes  
- 1 platform for attaching a demonstration foot.  
Dimensions: 180 x 55 cm.



**Maxi Display**  
CMK3DDISPL12

Max. capacity: 120 packs, 60 on each side.  
Order separately : 2 facing / 2 POP  
Can include a Feet Revelator™.  
Can also be used on one side only.  
Dimensions: 75 x 160 x 60 cm.



**Mid Display**  
CMKPMIDDI12

Max. capacity: 120 packs, 60 on each side.  
Order separately : 2 POP  
Can include a Feet Revelator™.  
Can also be used on one side only.  
Dimensions: 37 x 178 x 60 cm.



**Mini Display**  
CMKPMINSI15

Max. capacity: 45 packs, 30 packs on the front and 15 on the back.  
Can also be used on one side only.  
Dimensions: 36 x 128 x 36 cm.

## POSTERS



**Custom Made Custom Look Poster**  
CMKPOSBP12

50 x 70 cm Black Project poster.



**Bootfitting Poster**  
CMKPOSBOOTFI14

Information poster about Sidas' boot-fitting solutions for in-store display.



**Bootfitting Price Services Poster**  
CMKBOOTFITPR14

Boot-fitting prices poster for workshop services.



**Poster Winter 3D**  
CMKPOSWI3D14



**Custom Poster for Fit Stations**  
DE: CMKPOSCUSTOM\_01

Dimensions: 60 cm x 80 cm.



**PLV FlashFit**  
CMKPLVFF14







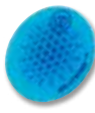













# MAPPING













INSOLES	Rental	 Sanisol 3D	 Rental 3D			
	3D	 Winter 3D Comfort	 Winter 3D	 Winter 3D Women		
	3Feet	 3Feet® High	 3Feet® Mid	 3Feet® Low		
	FLASHFIT™	 Winter+ Comfort	 Winter+	 Winter+ Slim		
	MODULO	 Racing				
	Custom	 Winter Custom Ski	 Winter Custom Wide	 Winter Custom Pro	 Winter Custom Pro Mesh	 Winter Custom Race
Heat	 Winter H flat		 Volcano Heat		 Custom Heat	 Heating element & cover

ON SKIN	On Skin protector	 Shin Protector	 Ankle Protector		

SOCKS	Specific	 UltraThin	 Protective Gel	 ProHeat	
	Performance	 Performance			
	3Feet	 Winter Low	 Winter Mid	 Winter High	

# MAPPING

BOOTWEAR	Ski Boots	 Full Thermo S-Max	 Full Thermo S-Pro	 Full Thermo S-RX W	 Full Thermo S-PRO W	
	Shells	 CX Max	 CX Pro	 Vector 120 V2	 S-RX W	 S-Pro W
	Thermo Innerboots	 Central High V3	 Central High Slim	 Central Woman H	 Central Woman	
	PU Innerboots	 PU Classic Comfort	 PU Classic V2	 PU Transfoam Flex	 PU Classic Flex W	
	Rental	 Rental Heat Ski Boot M	 Rental Heat Ski Boot W			

BOOT & SHOE ACCESSORIES	Tractions	 WALK TRACTION®	 WALK TRACTION			
	Booster	 Power Strap Men	 Power Strap Women			
	Buckles	 Flag Buckle	 Custom Buckle			
	Boot Bags	 Black Boot Bag	 Yellow Boot Bag	 Women Boot Bag	 Flag Boot Bag	 Shoe Bag
	Drying & Heating	 Hot Dryer	 Drywarmer			

ANALYSE	Foot analyse	 Press-Cam V4.0	 Podoscope M	 Feet Revelator	 Feet Measurer	 Footsizer
	Ski boot analyse	 Skier Analyse station	 Laser Alignment	 Fit stick + Light		

# MEASURING THE FOOT

## SIZES

A size is a series of measurements, expressed in points, that characterise a foot, last or shoe. There are different size systems, each with its own history and logic: **The Paris Point (EUR), the American Point (US) and the English Point (UK).**

**The Mondopoint (MP) system**, resulting from work carried out by more than 18 countries and governed by international standard ISO 9407, has been created to harmonise the scales.

The Mondopoint system measures the foot in centimetres.

## STEP 1: measurement of the length and width of the foot



• Analysis of the foot length



• Analysis of the foot width

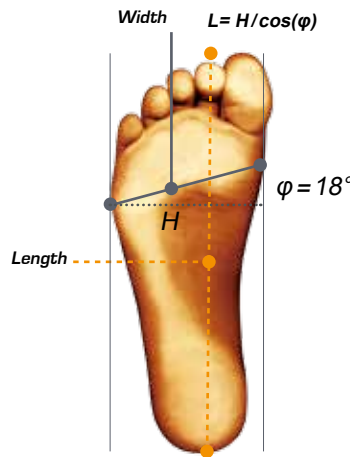

Foot sizer

## STEP 2: pressure analysis

• Analysis of the foot pressure



Feet Revelator™

1. Two pressure points
2. Anatomical pressure
3. Uniform pressure



## STEP 3: analysis of volume and shape

• Analysis of the volume and shape of the foot



































Podoscope



1. HIGH-arched foot
2. MEDIUM-arched foot
3. LOW-arched foot



# SIZE & FOAM CHART

Sizes	Insoles	Socks	Shells	Thermo Innerboots	PU Innerboots	Transfoam	Tongue sizes	Foam set colors (tongue)
<b>MP</b>								
20								
20 1/2								
21								
21 1/2						C 		
22	<b>XS</b> MP 22 - 23 EUR 35 - 36 UK 2 - 3 US 3 - 4	S (1)			C 	D 	1 BLACK	
22 1/2								
23			23.5	D	D 	E 		
23 1/2	<b>S</b> MP 23 1/2 - 24 1/2 EUR 37 - 38 UK 4 - 5 US 5 - 6	M (2)						
24			24.5	E	E 	F 	2 BLUE	
24 1/2								
25	25.5	F	F 	G 				
25 1/3	<b>M</b> MP 25 - 26 1/2 EUR 39 - 41 UK 6 - 7 US 7 - 8	L (3)						
25 1/2								
26			26.5	G	G 	H 	3 GREY	
26 1/2								
27	27.5	H	H 	I 				
27 1/2								
28	<b>L</b> MP 27 - 28 EUR 42 - 43 UK 8 - 9 US 9 - 10	XL (4)						
28 1/2			28.5	I	I 	J 	4 BLACK	
28 1/2								
29			29.5	J	J 	K 		
29 1/3								
29 1/2	<b>XL</b> MP 28 1/2 - 29 1/2 EUR 44 - 45 UK 10 - 11 US 11 - 12							
30			30.5	K	K 	L 		
30 1/2								
31								
31 1/2	<b>XXL</b> MP 29 1/2 EUR 46 - 48 UK 12 - 13 US 13 - 14				L 	M 		
31 1/2								
32								

# DISTRIBUTORS



## AUSTRALIA

REFLEX SPORTS PTY LIMITED  
4/16 DALTON STREET  
MITTAGONG NSW 2575  
PH.: +61 2 4872 1242  
FAX: +61 2 4872 1835  
sales@reflexsports.com.au  
www.reflexsports.com.au

## AUSTRIA

N2SPORTS Gesellschaft m.b.H  
Goethestrasse 8  
A-6845 Hohenems  
Ph.: +43 5576 74015  
Fax: +43 5576 74153  
office@nsports.at  
www.nsports.at

## BENELUX

X-FUNCTION BENELUX B.V.  
Koperslager 7  
6422 PR Heerlen  
Netherlands  
Ph.: +31-45-5466622  
Fax: +31-45-5466621  
verkoop@x-function.nl  
www.tck-sports.nl

## CHINA

BEIJING GOGIR TRADE LTD. CO.  
Pinggu Garden Of Zhongguancun  
Science Park Valley Area B No.1-363,  
Pinggu District, Beijing  
CHINA  
Ph.: +86 10 87958570  
Fax: +86 10 87958570  
concert3@hotmail.com  
www.sidaschina.com

## CZECH REPUBLIC / SLOVAKIA

SVORTO. CZ S.R.O.  
Průběžná 30  
100 00 PRAHA 10  
Ph.: +42 0241740341  
Fax: +42 0241740339  
sidas@svorto.cz  
www.sportovnivlozky.cz

## DENMARK

PIST TRADING  
Bregnerødvej 132B  
3460 BIRKERØD  
Ph.: +45 28448240  
pn@sidas.dk  
www.sidas.dk

## FINLAND

SAILCLEAN OY  
SOLBACKANTIE 17  
01760 VANTAA  
Ph.: +358 400-70.68.27  
snyffe@gmail.com

## FRANCE / ANDORRE

SIDAS Sport France  
18, rue Léon Béridot  
BP 353 - ZAC Champfeuillet  
38509 VOIRON CEDEX - France  
Ph.: +33 (0)4 76 67 07 24/ 11/ 14  
Fax: +33 (0)4 76 67 03 03  
sidassportfrance@sidas.com

## GERMANY

STC DISTRIBUTION GMBH  
Triesterstrasse 179  
8073 Feldkirchen bei Graz  
AUSTRIA  
Ph.: +43 316 243 793 0  
Fax: +43 316 243 793-10  
sales@stc-sport.com

## HUNGARY

FLEX 92 KFT.  
Baross u. 87  
2040 BUDAÖRS  
Ph./Fax: +36 23 414 699  
Mobile phone: +36 309402253  
flex92@t-online.hu

## ITALIA

VICH ITALIA S.R.L.  
Via Borgo Palazzo 274  
24125 BERGAMO  
Ph.: +39 035 4596078  
Fax: +39 035 0172273  
info@vichitalia.com  
www.vichitalia.com

## JAPAN

SIDAS JAPAN  
Atom Kannai 7F  
2-2-1 Bentendori Naka-ku  
YOKOHAMA  
231-0007 JAPAN  
Ph.: +81 045 263 9559  
Fax: +81 045 263 9558  
info@sidas.co.jp  
www.sidas.co.jp

## NEW ZEALAND

BRANDEX LTD  
204 Cumnor Terrace  
WOOLSTON 8241,  
CHRISTCHURCH  
Ph.: +64 3 3812190  
Fax: +64 3 3812191  
hq@brandex.co.nz

## NORTH AMERICA

SOZE GROUP  
3 - 3531 Viking Way  
Richmond BC V6V 1W1  
Canada  
Ph.: +1 604 732 9144  
Fax: +1 604 270 1906  
Toll Free: +1 866 732 9144  
office@thesozegroup.com  
www.thesozegroup.com

## NORWAY

WE SKI AS  
OKSENOYVEIEN 80  
1366 LYSAKER  
Ph.: +47 930 33 110  
Ph.: +47 959 59 797  
andre@weski.no  
www.weski.no

## POLAND

WINDSPORT SP. J  
ul. Zakopiańska 56 A  
30-418 KRAKÓW  
Ph.: +48 12 267 79 60  
Fax: +48 12 267 79 61  
sidas@sidas.pl  
www.sidas.pl

## RUSSIA

SGR COMPANY  
Montagnaya Str 4B  
BUILD 5  
107497 MOSCOW  
Ph.: +7 (495) 729 24 06  
info@sidas-russia.ru  
www.sidas-russia.ru

## SOUTH KOREA

PJTUNE CO.LTD  
135-815  
9F Mediacycenter 58-9 Nonhyeon  
1-dong  
Gangnamgu  
SEOUL  
Ph.: +82 22209 0250  
Fax: +82 22209 0260  
pjhjia@hotmail.com  
www.pjtune.com

## SPAIN / PORTUGAL

SIDAS SPAIN SL  
Vallirana 30 bajos  
08006 BARCELONA  
Ph.: +34 93 218 37 22  
Fax: +34 93 217 40 83  
sidas@sidas.net  
www.sidas.net

## SWEDEN

AG TRADING AB  
Fannys väg 5,  
131 54 NACKA  
Ph.: +46 8 6127980  
Fax: +46 8 165009  
info@agtrading.se  
www.agtrading.se

## SWITZERLAND

SIDAS SUISSE SARL  
C/o D4 Platz 3  
6039 ROOT LÄNGENBOLD  
Ph.: 0800 83 53 63  
Fax: +33 (0)4 76 67 03 03  
suisse@sidas.com

## UK & IRELAND

SIDAS, UK Ltd  
Bridge House  
1 Bridge Street,  
Kendal, Cumbria  
LA9 7DD  
Ph.: +44 15 39 72 58 17  
Fax: +44 15 39 72 96 61  
info@sidas.co.uk  
www.sidas.co.uk

## Sidas SAS

18, rue Léon Béridot - BP 353 -  
PA Champfeuillet Est  
38509 VOIRON CEDEX - France  
Ph. +33 (0)4 76 67 07 07  
Fax +33 (0)4 76 67 03 03  
E-mail: info@sidas.com



3 661267 086229